



Ball Spline

THK General Catalog

Ball Spline

THK General Catalog

A Product Descriptions

Classification of Ball Splines..... A3-4

Point of Selection A3-6

Flowchart for Selecting a Ball Spline..... A3-6

- Steps for Selecting a Ball Spline A3-6
- Selecting a Type A3-8
- Studying the Spline Shaft Strength A3-12
- Predicting the Service Life..... A3-20

Selecting a Preload A3-30

- Clearance in the Rotation Direction A3-30
- Preload and Rigidity A3-30
- Conditions and Guidelines for Selecting of a Preload .. A3-31

Determining the Accuracy..... A3-34

- Accuracy Grades A3-34
- Accuracy Standards A3-35

High Torque Caged Ball Spline

Models SLS, SLS-L and SLF..... A3-38

- Structure and Features A3-39
- Types and Features A3-42
- Housing Inner-diameter Tolerance A3-43

Dimensional Drawing, Dimensional Table

Model SLS A3-44

Model SLF A3-46

- Spline Shaft A3-48
- Accessories A3-50

High Torque Type Ball Spline

Models LBS, LBST, LBF, LBR and LBH .. A3-52

- Structure and Features A3-53
- Applications A3-54
- Types and Features A3-55
- Housing Inner-diameter Tolerance A3-57

Dimensional Drawing, Dimensional Table

Model LBS (Medium Load Type) A3-58

Model LBST (Heavy Load Type) A3-60

Model LBF (Medium Load Type) A3-62

Model LBR A3-64

Model LBH A3-66

Model LBS with Recommended Shaft End Shape .. A3-68

- Spline Shaft A3-69
- Accessories A3-72

Medium Torque Type Ball Spline

Models LT, LF, LT-X, LF-X, LFK-X, and LFH-X .. A3-74

- Structure and Features A3-75
- Types and Features A3-76
- Housing Inner-diameter Tolerance A3-79

Dimensional Drawing, Dimensional Table

Model LT A3-80

Model LF A3-82

Model LT-X A3-84

Model LF-X A3-86

Model LFK-X..... A3-88

Model LFH-X A3-90

Model LT with Recommended Shaft End Shape .. A3-92

- Spline Shaft A3-93
- Accessories A3-97

Rotary Ball Spline

Geared Type Models LBG and LBGT .. A3-98

- Structure and Features A3-99
- Types and Features A3-100
- Housing Inner-diameter Tolerance A3-101

Dimensional Drawing, Dimensional Table

Model LBG..... A3-102

Model LBGT A3-104

- Spline Shaft A3-106

Rotary Ball Spline

Support Bearing Type Models LTR and LTR-A .. A3-110

- Structure and Features A3-111
- Types and Features A3-112
- Housing Inner-diameter Tolerance A3-113

Dimensional Drawing, Dimensional Table

Model LTR-A Compact Type..... A3-114

Model LTR A3-116

- Spline Shaft A3-118

• Permissible Rotational Speed for Rotary Ball Splines .. A3-120

Maximum Manufacturing Length by Accuracy .. A3-121

Point of Design A3-123

Checking List for Spline Shaft End Shape .. A3-123

Housing Inner-diameter Tolerance A3-124

Positions of the Spline-nut Keyway and Mounting Holes .. A3-124

Options A3-126

Lubrication A3-126

Material and Surface Treatment A3-126

Contamination Protection A3-126

- Specifications of the Bellows A3-127

Model No. A3-128

- Model Number Coding..... A3-128

Precautions on Use A3-129

B Support Book (Separate)

Features and Types	B3-4
Features of the Ball Spline	B3-4
• Structure and Features	B3-4
Classification of Ball Splines.....	B3-6
Point of Selection	B3-8
Flowchart for Selecting a Ball Spline.....	B3-8
• Steps for Selecting a Ball Spline	B3-8
• Selecting a Type	B3-10
• Studying the Spline Shaft Strength	B3-14
• Predicting the Service Life.....	B3-19
• Example of Calculating the Service Life....	B3-25
Mounting Procedure and Maintenance ..	B3-31
Assembling the Ball Spline.....	B3-31
• Mounting the Spline	B3-31
• Installing the Spline Nut	B3-33
• Installation of the Spline Shaft.....	B3-33
Lubrication	B3-34
Options	B3-35
Material and Surface Treatment	B3-35
Contamination Protection	B3-35
Model No.	B3-36
• Model Number Coding.....	B3-36
Precautions on Use	B3-37

Classification of Ball Splines

Ball Spline

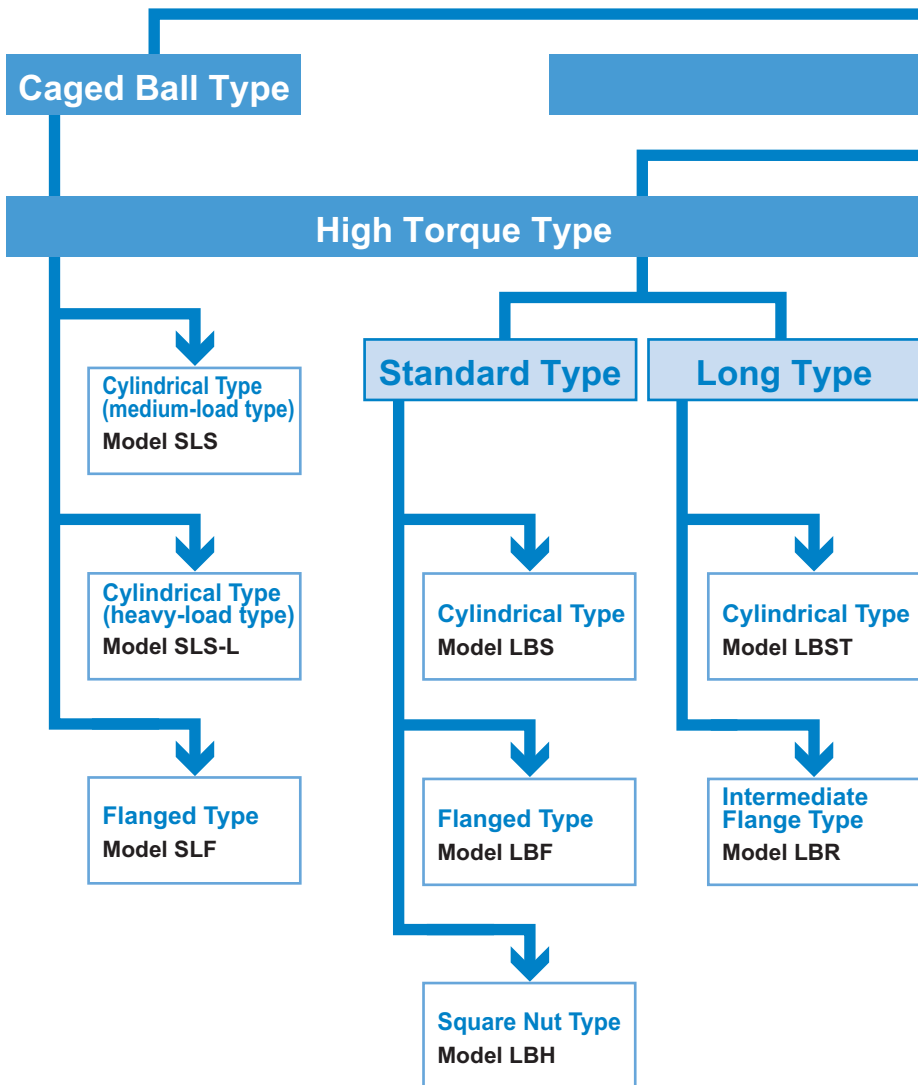

Full-ball Type

Medium torque Type

Standard Type

Cylindrical Type
Model LT

Flanged Type
Model LF

Compact Type

Cylindrical Type
Model LT-X

Flanged Type
Model LF-X

Flanged Type
Model LFK-X

Flanged Type
Model LFH-X

Rotary Type

Geared Type

Standard Type
Model LBG

Thrust Raceway
Type
Model LBG-T

Support Bearing Type

Standard Type
Model LTR

Compact Type
Model LTR-A

Flowchart for Selecting a Ball Spline

Steps for Selecting a Ball Spline

The following is a flowchart to reference when selecting a Ball Spline.

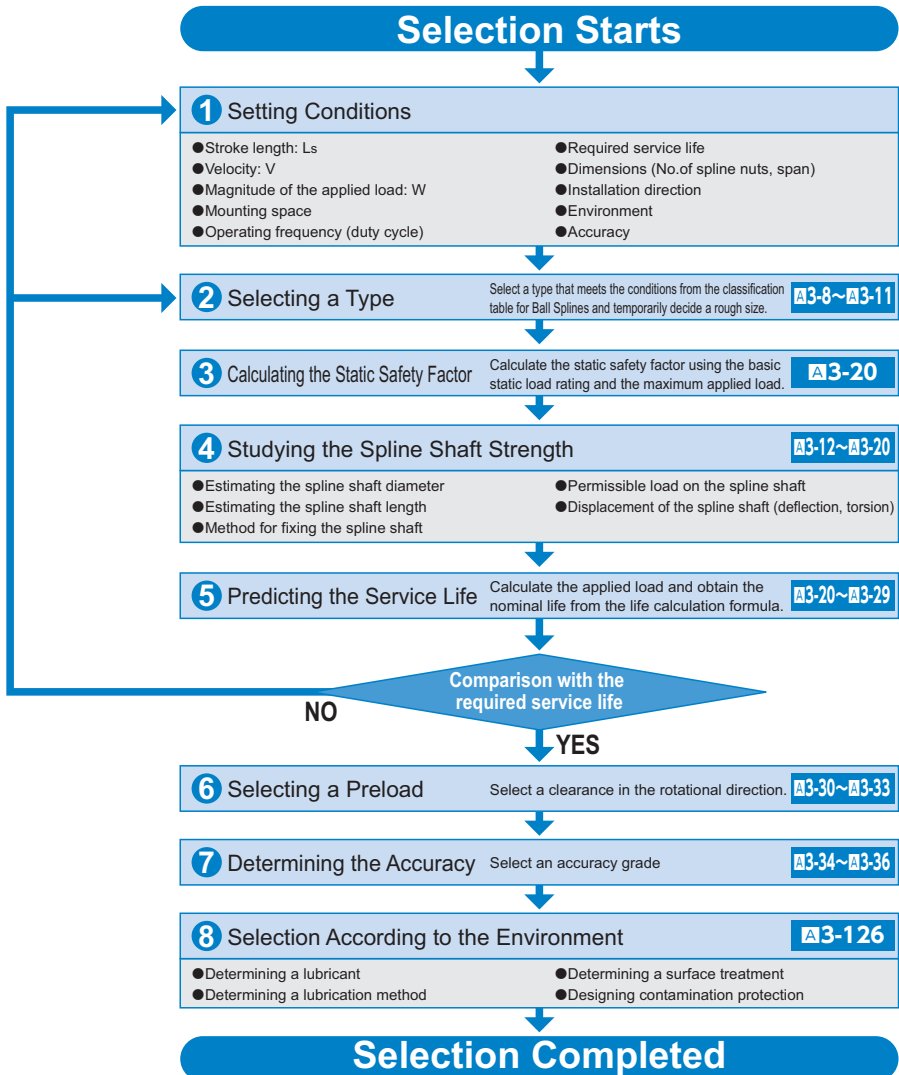

Point of Selection







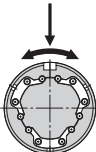
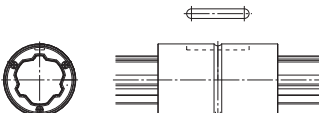
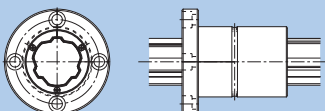
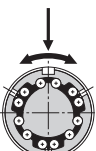
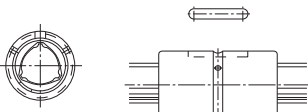
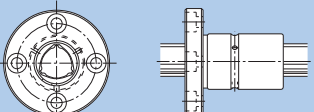
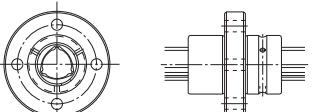
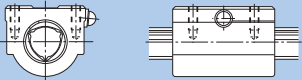



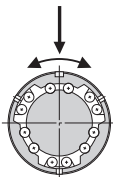

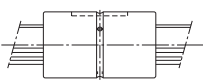

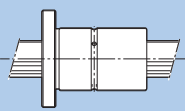
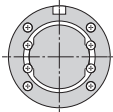
Flowchart for Selecting a Ball Spline

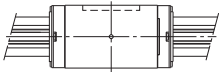
Selecting a Type

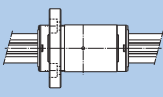
There are three types of the Ball Spline: high torque type, medium torque type and rotary type. You can choose a type according to the intended use. In addition, wide arrays of spline nut shapes are available for each type, enabling the user to choose a desired shape according to the mounting or service requirements.

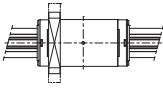
Classification		Type	Shape	Shaft diameter
High torque Caged Ball type		Type SLS Type SLS-L		Nominal shaft diameter 25 to 100 mm
		Type SLF		Nominal shaft diameter 25 to 100 mm
High torque type		Type LBS Type LBST		Nominal shaft diameter 15 to 150 mm
		Type LBF		Nominal shaft diameter 15 to 100 mm
		Type LBR		Nominal shaft diameter 15 to 100 mm
		Type LBH		Nominal shaft diameter 15 to 50 mm

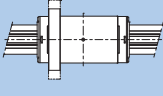
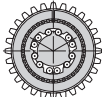
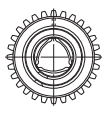
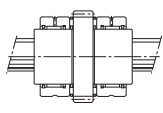
Specification Table	Structure and features	Major application
A3-44	<ul style="list-style-type: none"> ● Redesigning the shape of the conventional high torque type spline shaft to be more circular significantly improves its torsion and flexural rigidity. ● Models SLS/SLF adopt the caged-ball technology to enable the circulating motion of evenly spaced balls to be maintained and high-speed response to be achieved, the cycle time of the machine can be improved. ● Models SLS/SLF adopt the caged-ball technology, they eliminate collision and mutual friction between balls, and realize low noise, pleasant running sound and low particle generation. ● Models SLS/SLF adopt the caged-ball technology to substantially increase the grease retention, thus achieving long-term maintenance-free operation. ● Models SLS/SLF adopt the caged-ball technology and a new circulation method, thus achieving stable and smooth motion with small rolling fluctuation. 	<ul style="list-style-type: none"> ● Column and arm of industrial robot ● Automatic loader ● Transfer machine ● Automatic conveyance system ● Tire molding machine ● Spindle of spot-welding machine ● Guide shaft of high-speed automatic coating machine ● Riveting machine ● Wire winder ● Work head of electric discharge machine ● Spindle drive shaft of grinding machine ● Speed gears ● Precision indexing machine
A3-46		
A3-58	<ul style="list-style-type: none"> ● The spline shaft has three crests equidistantly formed at angles of 120°. On both sides of each crest, two rows (six rows in total) of balls are arranged to hold the crest from both sides. The angular-contact design of the ball contact areas allows an appropriate preload to be evenly applied. ● Since the balls circulate inside the spline nut, the outer dimensions of the spline nut are compactly designed. ● Even under a large preload, smooth straight motion is achieved. ● Since the contact angle is large (45°) and the displacement is minimal, high rigidity is achieved. ● No angular backlash occurs. ● Capable of transmitting a large torque. 	
A3-62		
A3-64		
A3-66		

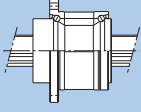
Classification		Type	Shape		Shaft diameter
Medium torque type		Type LT			Nominal shaft diameter 4 to 100 mm
		Type LF			Nominal shaft diameter 6 to 50 mm
		Type LT-X			Nominal shaft diameter 4 to 30 mm
		Type LF-X			Nominal shaft diameter 4 to 30 mm
		Type LFK-X			Nominal shaft diameter 5 to 30 mm
		Type LFH-X			Nominal shaft diameter 5 to 30 mm
Rotary type	Rotation 	Type LBG Type LBG T			Nominal shaft diameter 20 to 85 mm
	Rotation 	Type LTR-A Type LTR			Nominal shaft diameter 8 to 60 mm

Point of Selection

Selecting a Type

Specification Table	Structure and features	Major application	
A3-80	<ul style="list-style-type: none"> The spline shaft has two to three crests. On both sides of each crest, two rows (four to six rows in total) of balls are arranged to hold the crest from both sides. This design allows an appropriate preload to be evenly applied. The contact angle of 20° and an appropriate preload level eliminate angular backlash, providing high-torque moment rigidity. 	<ul style="list-style-type: none"> Die-set shaft and similar applications requiring straight motion under a heavy load Loading system and similar applications requiring rotation to a given angle at a fixed position Automatic gas-welding machine spindle and similar applications requiring a whirl-stop on one shaft 	<ul style="list-style-type: none"> Column and arm of industrial robot Spot-welding machine Riveting machine Book-binding machine Automatic filler XY recorders Automatic spinner Optical measuring instrument
A3-82			
A3-84	<ul style="list-style-type: none"> The length and external diameter of the LT-X ball spline's outer cylinder are the same as those of an LM-series linear bushing, meaning the nut can be replaced with a linear bushing. 		
A3-86	<ul style="list-style-type: none"> The length and external diameter of the LF-X ball spline's nut are the same as those of the Model LMF linear bushing, meaning the nut can be replaced with a linear bushing. 		
A3-88	<ul style="list-style-type: none"> The Model LFK-X is a lightweight and compact product designed with a lower core height than the Model LF-X. 		
A3-90	<ul style="list-style-type: none"> The Model LFH-X is a lightweight and compact product designed with a lower core height than the Model LFK-X. 		
A3-102	<ul style="list-style-type: none"> A unit type that has the same contact structure as model LBS. The flange circumference on the spline nut is machined to have gear teeth, and radial and thrust needle bearings are compactly combined on the circumference of the spline nut. 	<ul style="list-style-type: none"> Speed gears for high torque transmission 	
A3-114	<ul style="list-style-type: none"> A lightweight and compact type based on model LT, but has a spline nut circumference machined to have angular-contact type ball raceways to accommodate support bearings. 	<ul style="list-style-type: none"> Z axis of scalar robot Wire winder 	

Studying the Spline Shaft Strength

The spline shaft of the Ball Spline is a compound shaft capable of receiving a radial load and torque. When the load and torque are large, the spline shaft strength must be taken into account.

[Spline Shaft Receiving a Bending Load]

When a bending load is applied to the spline shaft of a Ball Spline, obtain the spline shaft diameter using the equation (1) below.

$$M = \sigma \cdot Z \quad \text{and} \quad Z = \frac{M}{\sigma} \quad \dots\dots\dots(1)$$

M : Maximum bending moment acting on the spline shaft (N·mm)

σ : Permissible bending stress of the spline shaft (98N/mm²)

Z : Modulus section factor of the spline shaft (mm³)

(see Table3 on **A3-17**, Table4 on **A3-18**, Table5 on **A3-19** and Table6 on **A3-20**)

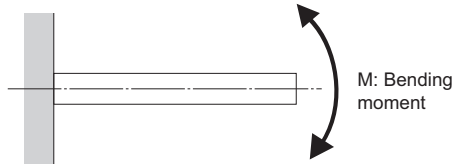

[Reference] Section Modulus (Solid Circle)

$$Z = \frac{\pi \cdot d^3}{32}$$

Z : Section Modulus (mm³)

d : Shaft outer diameter (mm)

[Spline Shaft Receiving a Torsion Load]

When a torsion load is applied on the spline shaft of a Ball Spline, obtain the spline shaft diameter using the equation (2) below.

$$T = \tau_a \cdot Z_p \quad \text{and} \quad Z_p = \frac{T}{\tau_a} \quad \dots\dots\dots(2)$$

T : Maximum torsion moment (N·mm)

τ_a : Permissible torsion stress of the spline shaft (49N/mm²)

Z_p : Polar modulus of section of the spline nut (mm³)

(see Table3 on **A3-17**, Table4 on **A3-18**, Table5 on **A3-19** and Table6 on **A3-20**)

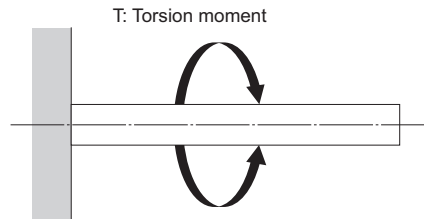

[Reference] Section Modulus (Solid Circle)

$$Z_p = \frac{\pi \cdot d^3}{16}$$

Z_p : Section modulus (mm³)

d : Shaft outer diameter (mm)

[When the Spline Shaft Simultaneously Receives a Bending Load and a Torsion Load]

When the spline shaft of a Ball Spline receives a bending load and a torsion load simultaneously, calculate two separate spline shaft diameters: one for the equivalent bending moment (M_e) and the other for the equivalent torsion moment (T_e). Then, use the greater value as the spline shaft diameter.

Equivalent bending moment

$$M_e = \frac{M + \sqrt{M^2 + T^2}}{2} = \frac{M}{2} \left\{ 1 + \sqrt{1 + \left(\frac{T}{M}\right)^2} \right\} \dots\dots\dots(3)$$

$$M_e = \sigma \cdot Z$$

Equivalent torsion moment

$$T_e = \sqrt{M^2 + T^2} = M \cdot \sqrt{1 + \left(\frac{T}{M}\right)^2} \dots\dots\dots(4)$$

$$T_e = \tau_a \cdot Z_p$$

[Rigidity of the Spline Shaft]

The rigidity of the spline shaft is expressed as a torsion angle per meter of shaft length. Its value should be limited within $1^\circ/4$.

$$\theta = 57.3 \times \frac{T \cdot L}{G \cdot I_p} \dots\dots\dots(5)$$

$$\text{Rigidity of the shaft} = \frac{\text{Torsion angle}}{\text{Unit length}} = \frac{\theta \cdot \ell}{L} < \frac{1^\circ}{4}$$

θ : Torsion angle (°)

L : Spline shaft length (mm)

G : Transverse elastic modulus
($7.9 \times 10^4 \text{N/mm}^2$)

ℓ : Unit length (1000mm)

I_p : Polar moment of inertia (mm⁴)

(see Table3 on **A3-17**, Table4 on **A3-18**, Table5 on **A3-19** and Table6 on **A3-20**)

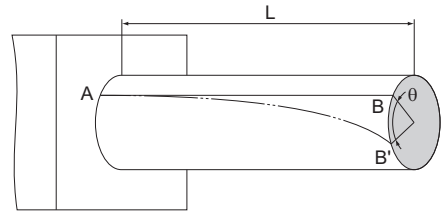

[Deflection and Deflection Angle of the Spline Shaft]

The deflection and deflection angle of the Ball Spline shaft need to be calculated using equations that meet the relevant conditions. Table1 and Table2 represent these conditions and the corresponding equations.

Table3 on **A3-17**, Table4 on **A3-18**, Table5 on **A3-19** and Table6 on **A3-20** show the section modulus of the spline shaft (Z) and the second moment of area (I). Using the Z and I values from the tables, the strength and displacement (deflection) of a typical ball spline within each model type can be obtained.

Table1 Deflection and Deflection Angle Equations

Support method	Condition	Deflection equation	Deflection angle equation
Both ends free		$\delta_{\max} = \frac{P\ell^3}{48EI}$	$i_1 = 0$ $i_2 = \frac{P\ell^2}{16EI}$
Both ends fastened		$\delta_{\max} = \frac{P\ell^3}{192EI}$	$i_1 = 0$ $i_2 = 0$
Both ends free		$\delta_{\max} = \frac{5p\ell^4}{384EI}$	$i_2 = \frac{p\ell^3}{24EI}$
Both ends fastened		$\delta_{\max} = \frac{p\ell^4}{384EI}$	$i_2 = 0$

Table2 Deflection and Deflection Angle Equations

Support method	Condition	Deflection equation	Deflection angle equation
One end fastened		$\delta_{\max} = \frac{P\ell^3}{3EI}$	$i_1 = \frac{P\ell^2}{2EI}$ $i_2 = 0$
One end fastened		$\delta_{\max} = \frac{p\ell^4}{8EI}$	$i_1 = \frac{p\ell^3}{6EI}$ $i_2 = 0$
Both ends free		$\delta_{\max} = \frac{\sqrt{3}M_0\ell^2}{216EI}$	$i_1 = \frac{M_0\ell}{12EI}$ $i_2 = \frac{M_0\ell}{24EI}$
Both ends fastened		$\delta_{\max} = \frac{M_0\ell^2}{216EI}$	$i_1 = \frac{M_0\ell}{16EI}$ $i_2 = 0$

 δ_{\max} : Maximum deflection (mm) M_0 : Moment (N·mm) ℓ : Span (mm)I: Geometrical moment of inertia (mm⁴) i_i : Deflection angle at loading point i_2 : Deflection angle at supporting point

P: Concentrated load (N)

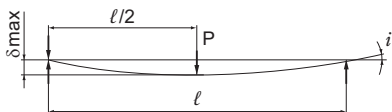
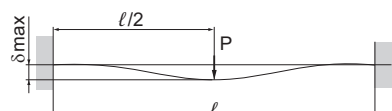
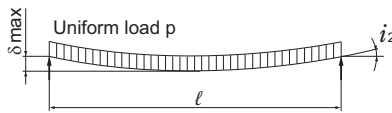
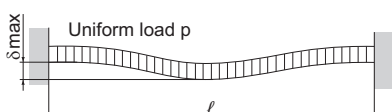
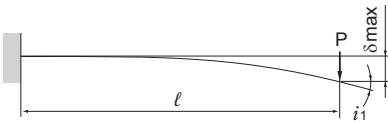
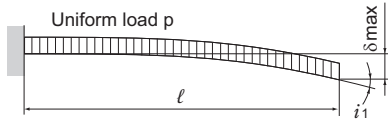
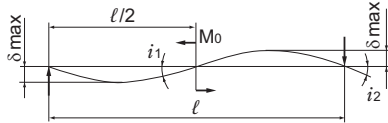
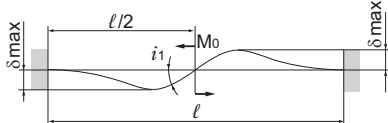
p: Uniform load (N/mm)

E: Modulus of longitudinal elasticity 2.06×10^5 (N/mm²)

[Dangerous Speed of the Spline Shaft]

When a Ball Spline shaft is used to transmit power while rotating, as the rotational speed of the shaft increases, the rotation cycle nears the natural frequency of the spline shaft. It may cause resonance and eventually result in inability to move. Therefore, the maximum rotational speed of the shaft must be limited to below the dangerous speed that does not cause resonance.

The dangerous speed of the spline shaft is obtained using the equation (6).

(0.8 is multiplied as a safety factor)

If the shaft's rotation cycle exceeds or nears the resonance point during operation, it is necessary to reconsider the spline shaft diameter.

● Dangerous Speed

$$N_c = \frac{60\lambda^2}{2\pi \cdot \ell_b^2} \cdot \sqrt{\frac{E \times 10^3 \cdot I}{\gamma \cdot A}} \times 0.8 \quad \cdots (6)$$

N_c : Dangerous speed (min⁻¹)

ℓ_b : Distance between two mounting surfaces (mm)

E : Young's modulus (2.06 × 10⁵ N/mm²)

I : Minimum geometrical moment of inertia of the shaft (mm⁴)

$$I = \frac{\pi}{64} d^4 \quad d: \text{Minor diameter (mm)}$$

(see Table10, Table11, Table12 and Table13 on **A3-24**)

γ : Density (specific gravity)
(7.85 × 10⁻⁶kg/mm³)

$$A = \frac{\pi}{4} d^2 \quad d: \text{Minor diameter (mm)}$$

(see Table10, Table11, Table12 and Table13 on **A3-24**)

A : Spline shaft cross-sectional area (mm²)

λ : Factor according to the mounting method

(1) Fixed - free $\lambda=1.875$

(2) Supported - supported $\lambda=3.142$

(3) Fixed - supported $\lambda=3.927$

(4) Fixed - fixed $\lambda=4.73$

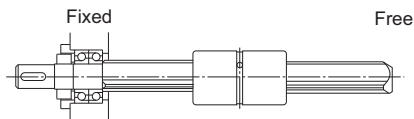

Fixed - free

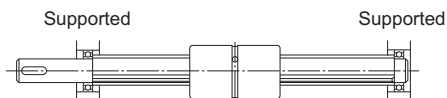

Supported - supported

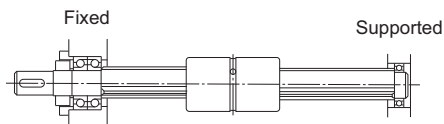

Fixed - supported

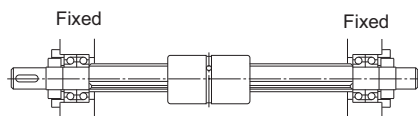

Fixed - fixed

[Cross-sectional Characteristics of the Spline Shaft]

● Cross-sectional Characteristics of the Spline Shaft for Ball Spline Models SLS, SLS-L and SLF

Table3 Cross-sectional Characteristics of the Spline Shaft for Models SLS, SLS-L and SLF

Nominal shaft diameter		I: Geometrical moment of inertia mm ⁴	Z: Modulus section mm ³	I _p : Polar moment of inertia mm ⁴	Z _p : Section modulus mm ³
25	Solid shaft	1.61×10^4	1.29×10^3	3.22×10^4	2.57×10^3
	Hollow shaft	1.51×10^4	1.20×10^3	3.01×10^4	2.41×10^3
30	Solid shaft	3.33×10^4	2.22×10^3	6.65×10^4	4.43×10^3
	Hollow shaft	3.00×10^4	2.00×10^3	6.01×10^4	4.00×10^3
40	Solid shaft	1.09×10^5	5.47×10^3	2.19×10^5	1.09×10^4
	Hollow shaft	9.79×10^4	4.90×10^3	1.96×10^5	9.79×10^3
50	Solid shaft	2.71×10^5	1.08×10^4	5.41×10^5	2.17×10^4
	Hollow shaft	2.51×10^5	1.01×10^4	5.03×10^5	2.01×10^4
60	Solid shaft	5.83×10^5	1.94×10^4	1.17×10^6	3.89×10^4
	Hollow shaft	5.32×10^5	1.77×10^4	1.06×10^6	3.54×10^4
70	Solid shaft	1.06×10^6	3.02×10^4	2.11×10^6	6.04×10^4
80	Solid shaft	1.82×10^6	4.55×10^4	3.64×10^6	9.10×10^4
	Hollow shaft	1.45×10^6	3.62×10^4	2.90×10^6	7.24×10^4
100	Solid shaft	4.50×10^6	9.00×10^4	9.00×10^6	1.80×10^5
	Hollow shaft	3.48×10^6	6.96×10^4	6.96×10^6	1.36×10^5

Note) For the hole-shape of the hollow spline shaft, see **A3-48**.

● **Cross-sectional Characteristics of the Spline Shaft for Ball Spline Models LBS, LBST, LBF, LBR, LBH, LBG and LBGT**

Table4 Cross-sectional Characteristics of the Spline Shaft for Models LBS, LBST, LBF, LBR, LBH, LBG and LBGT

Nominal shaft diameter		I: Geometrical moment of inertia mm ⁴	Z: Modulus section mm ³	I _p : Polar moment of inertia mm ⁴	Z _p : Section modulus mm ³
15	Solid shaft	1.27×10^3	2.00×10^2	2.55×10^3	4.03×10^2
20	Solid shaft	3.82×10^3	4.58×10^2	7.72×10^3	9.26×10^2
	Hollow shaft	3.79×10^3	4.56×10^2	7.59×10^3	9.11×10^2
25	Solid shaft	9.62×10^3	9.14×10^2	1.94×10^4	1.85×10^3
	Hollow shaft	9.50×10^3	9.05×10^2	1.90×10^4	1.81×10^3
30	Solid shaft	1.87×10^4	1.50×10^3	3.77×10^4	3.04×10^3
	Hollow shaft	1.78×10^4	1.44×10^3	3.57×10^4	2.88×10^3
40	Solid shaft	6.17×10^4	3.69×10^3	1.25×10^5	7.46×10^3
	Hollow shaft	5.71×10^4	3.42×10^3	1.14×10^5	6.84×10^3
50	Solid shaft	1.49×10^5	7.15×10^3	3.01×10^5	1.45×10^4
	Hollow shaft	1.34×10^5	6.46×10^3	2.69×10^5	1.29×10^4
60	Solid shaft	3.17×10^5	1.26×10^4	6.33×10^5	2.53×10^4
	Hollow shaft	2.77×10^5	1.11×10^4	5.54×10^5	2.21×10^4
70	Solid shaft	5.77×10^5	1.97×10^4	1.16×10^6	3.99×10^4
	Hollow shaft	5.07×10^5	1.74×10^4	1.01×10^6	3.49×10^4
85	Solid shaft	1.33×10^6	3.69×10^4	2.62×10^6	7.32×10^4
	Hollow shaft	1.11×10^6	3.10×10^4	2.22×10^6	6.20×10^4
100	Solid shaft	2.69×10^6	6.25×10^4	5.33×10^6	1.25×10^5
	Hollow shaft	2.18×10^6	5.10×10^4	4.37×10^6	1.02×10^5
120	Solid shaft	5.95×10^6	1.13×10^5	1.18×10^7	2.26×10^5
	Hollow shaft	5.28×10^6	1.01×10^5	1.06×10^7	2.02×10^5
150	Solid shaft	1.61×10^7	2.40×10^5	3.20×10^7	4.76×10^5
	Hollow shaft	1.40×10^7	2.08×10^5	2.79×10^7	4.16×10^5

Note.) For the hole-shape of the hollow spline shaft, see **A3-69** and **A3-106**.

● Cross-sectional Characteristics of the Spline Shaft for Ball Spline Models LT, LF, LTR and LTR-A

Table5 Cross-sectional Characteristics of the Spline Shaft for Models LT, LF, LTR and LTR-A

Nominal shaft diameter		I: Geometrical moment of inertia mm ⁴	Z: Modulus section mm ³	I _p : Polar moment of inertia mm ⁴	Z _p : Section modulus mm ³	
4	Solid shaft	11.39	5.84	22.78	11.68	
5	Solid shaft	27.88	11.43	55.76	22.85	
6	Solid shaft	57.80	19.7	1.19×10 ²	40.50	
	Hollow shaft Type K	55.87	18.9	1.16×10 ²	39.20	
8	Solid shaft	1.86×10 ²	47.4	3.81×10 ²	96.60	
	Hollow shaft Type K	1.81×10 ²	46.0	3.74×10 ²	94.60	
10	Solid shaft	4.54×10 ²	92.6	9.32×10 ²	1.89×10 ²	
	Hollow shaft Type K	4.41×10 ²	89.5	9.09×10 ²	1.84×10 ²	
13	Solid shaft	1.32×10 ³	2.09×10 ²	2.70×10 ³	4.19×10 ²	
	Hollow shaft Type K	1.29×10 ³	2.00×10 ²	2.63×10 ³	4.09×10 ²	
16	Solid shaft	3.09×10 ³	3.90×10 ²	6.18×10 ³	7.80×10 ²	
	Hollow shaft	Type K	2.97×10 ³	3.75×10 ²	5.95×10 ³	7.51×10 ²
		Type N	2.37×10 ³	2.99×10 ²	4.74×10 ³	5.99×10 ²
20	Solid shaft	7.61×10 ³	7.67×10 ²	1.52×10 ⁴	1.53×10 ³	
	Hollow shaft	Type K	7.12×10 ³	7.18×10 ²	1.42×10 ⁴	1.43×10 ³
		Type N	5.72×10 ³	5.77×10 ²	1.14×10 ⁴	1.15×10 ³
25	Solid shaft	1.86×10 ⁴	1.50×10 ³	3.71×10 ⁴	2.99×10 ³	
	Hollow shaft	Type K	1.75×10 ⁴	1.41×10 ³	3.51×10 ⁴	2.83×10 ³
		Type N	1.34×10 ⁴	1.08×10 ³	2.68×10 ⁴	2.16×10 ³
30	Solid shaft	3.86×10 ⁴	2.59×10 ³	7.71×10 ⁴	5.18×10 ³	
	Hollow shaft	Type K	3.53×10 ⁴	2.37×10 ³	7.07×10 ⁴	4.74×10 ³
		Type N	2.90×10 ⁴	1.95×10 ³	5.80×10 ⁴	3.89×10 ³
32	Solid shaft	5.01×10 ⁴	3.15×10 ³	9.90×10 ⁴	6.27×10 ³	
	Hollow shaft	Type K	4.50×10 ⁴	2.83×10 ³	8.87×10 ⁴	5.61×10 ³
		Type N	3.64×10 ⁴	2.29×10 ³	7.15×10 ⁴	4.53×10 ³
40	Solid shaft	1.22×10 ⁵	6.14×10 ³	2.40×10 ⁵	1.21×10 ⁴	
	Hollow shaft	Type K	1.10×10 ⁵	5.55×10 ³	2.17×10 ⁵	1.10×10 ⁴
		Type N	8.70×10 ⁴	4.39×10 ³	1.71×10 ⁵	8.64×10 ³
50	Solid shaft	2.97×10 ⁵	1.20×10 ⁴	5.94×10 ⁵	2.40×10 ⁴	
	Hollow shaft	Type K	2.78×10 ⁵	1.12×10 ⁴	5.56×10 ⁵	2.24×10 ⁴
		Type N	2.14×10 ⁵	8.63×10 ³	4.29×10 ⁵	1.73×10 ⁴
60	Solid shaft	6.16×10 ⁵	2.07×10 ⁴	1.23×10 ⁶	4.14×10 ⁴	
	Hollow shaft Type K	5.56×10 ⁵	1.90×10 ⁴	1.13×10 ⁶	3.79×10 ⁴	
80	Solid shaft	1.95×10 ⁶	4.91×10 ⁴	3.90×10 ⁶	9.82×10 ⁴	
	Hollow shaft Type K	1.58×10 ⁶	3.97×10 ⁴	3.15×10 ⁶	7.95×10 ⁴	
100	Solid shaft	4.78×10 ⁶	9.62×10 ⁴	9.56×10 ⁶	1.92×10 ⁵	
	Hollow shaft Type K	3.76×10 ⁶	7.57×10 ⁴	7.52×10 ⁶	1.51×10 ⁵	

Note) For the hole-shape of the hollow spline shaft.
 For type K: see **A3-94** and **A3-118**.
 For type N: see **A3-94** and **A3-118**.

● Cross-sectional Characteristics of the Spline Shaft for Ball Spline Models LT-X, LF-X, LFK-X, and LFH-X

Table6 Cross-sectional Characteristics of the Spline Shaft for Models LT-X, LF-X, LFK-X, and LFH-X

Nominal shaft diameter		I: Geometrical moment of inertia mm ⁴	Z: Modulus section mm ³	I _p : Polar moment of inertia mm ⁴	Z _s : Section modulus mm ³
4	Solid shaft	11.2	5.7	23.2	11.8
5	Solid shaft	27.7	11.3	57.2	23.3
6	Solid shaft	57.7	19.6	119.1	40.4
8	Solid shaft	175.6	45	366.2	93.9
10	Solid shaft	422.3	86.5	896.9	183.8
	Type K	409.7	84	871.7	178.6
13	Solid shaft	1215.3	191.3	2574.6	405.3
	Type K	1184.6	186.5	2513.2	395.6
16	Solid shaft	2734.3	350.8	5844.5	749.7
	Type K	2616.4	335.6	5608.8	719.5
	Type N	2015.6	258.6	4407.2	565.4
20	Solid shaft	7043.9	716.5	14731.7	1498.5
	Type K	6553	666.6	13749.9	1398.7
	Type N	5158.1	524.7	10960.2	1114.9
25	Solid shaft	17268.2	1404.2	36067.4	2932.9
	Type K	16250.3	1321.4	34031.6	2767.4
	Type N	12115.2	985.2	25761.4	2094.8
30	Solid shaft	36115.8	2444.1	75160	5086.3
	Type K	32898.8	2226.4	68726.1	4650.9
	Type N	26569.7	1798	56067.4	3794.2

Predicting the Service Life

[Static Safety Factor]

To calculate a load applied to the ball spline, you must first know the average load used to calculate the service life and the maximum load used to calculate the static safety factor.

In particular, if the system starts and stops frequently, or if impact loads are applied, a large moment load or torque caused by overhung loads may be applied to the system. When selecting a model number, make sure that the desired model is capable of handling the required maximum load (whether stationary or in motion). The reference values for the static safety factor are shown in the table below.

$$f_s = \frac{f_T \cdot f_c \cdot C_0}{P_{\max}}$$

f_s : Static safety factor

C_0 : Basic static load rating* (N)

P_{\max} : Maximum applied load (N)

f_T : Temperature factor (see Fig.1 on **A3-23**)

f_c : Contact factor (see Table8 on **A3-23**)

*The basic static load rating is a static load of a defined direction and size where the sum of the permanent deformation of the ball and that of the rolling groove at the contact area under maximum stress is 0.0001 times the ball diameter.

Table7 Reference Values of Static Safety Factor (f_s)

Machine using the Ball Spline	Load conditions	Minimum reference values
General industrial machinery	Without vibration or impact	3.0 to 6.0
	With vibration or impact	4.0 to 7.0
	With vibration or impact under combined loads	5.0 to 8.0

*The reference values for the static safety factor may vary depending on the load conditions as well as the environment, lubrication status, precision of the mounted surface, and/or rigidity.

[Nominal Life]

The service life of a Ball Spline varies from unit to unit even if they are manufactured through the same process and used in the same operating conditions. Therefore, the nominal life defined below is normally used as a guidepost for obtaining the service life of a Ball Spline.

Nominal life is the total travel distance that 90% of a group of identical ball splines independently operating under the same conditions can achieve without showing flaking (scale-like pieces on a metal surface).

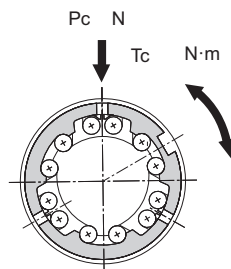

[Calculating the Nominal Life]

The nominal life of a Ball Spline varies with types of loads applied during operation: torque load, radial load and moment load. The corresponding nominal life values are obtained using the equations (7) to (12) below. (The basic load ratings in these loading directions are indicated in the specification table for the corresponding model number.)

● Calculating the Nominal Life

The nominal life of the THK ball spline is defined as 50 km. The nominal life (L_{10}) is calculated from the basic dynamic load rating (C) and the load acting on the ball spline (P_c) using the following formulas.

- When a Torque Load is Applied

$$L_{10} = \left(\frac{C_T}{T_c} \right)^3 \times 50 \quad \dots\dots(7)$$

- When a Radial Load is Applied

$$L_{10} = \left(\frac{C}{P_c} \right)^3 \times 50 \quad \dots\dots(8)$$

L_{10}	: Nominal life	(km)
C_T	: Basic dynamic torque rating	(N·m)
C	: Basic dynamic load rating	(N)
T_c	: Calculated torque applied	(N·m)
P_c	: Calculated radial load	(N)

*These nominal life formulas may not apply if the length of the stroke is less than or equal to twice the length of the ball spline nut.

When comparing the nominal life (L_{10}), you must take into account whether the basic dynamic load rating was defined based on 50 km or 100 km. Convert the basic dynamic load rating based on ISO 14728-1 as necessary.

ISO-regulated basic dynamic load rating conversion formula:

$$C_{100} = \frac{C_{50}}{1.26}$$

C_{50}	: Basic dynamic load rating based on a nominal life of 50 km
C_{100}	: Basic dynamic load rating based on a nominal life of 100 km

● Calculating the Modified Nominal Life

During use, a ball spline may be subjected to vibrations and shocks as well as fluctuating loads, which are difficult to detect. In addition, the operating temperature and having nuts arranged in close contact will significantly impact the service life. Taking these factors into account, the modified nominal life (L_{10m}) can be calculated according to the following formulas (9) and (10).

- Modified factor α

$$\alpha = \frac{f_T \cdot f_C}{f_W}$$

α	: Modified factor	
f_T	: Temperature factor	(see Fig.1 on A3-23)
f_C	: Contact factor	(see Table8 on A3-23)
f_W	: Load factor	(see Table 9 on A3-23)

- Modified nominal life L_{10m}

- When a Torque Load is Applied

$$L_{10m} = \left(\alpha \times \frac{C_T}{T_C} \right)^3 \times 50 \quad \dots\dots(9)$$

L_{10m}	: Modified nominal life	(km)
C_T	: Basic dynamic torque rating	(N·m)
C	: Basic dynamic load rating	(N)
T_C	: Calculated torque applied	(N·m)
P_C	: Calculated radial load	(N)

- When a Radial Load is Applied

$$L_{10m} = \left(\alpha \times \frac{C}{P_C} \right)^3 \times 50 \quad \dots\dots(10)$$

● When a Torque Load and a Radial Load are Simultaneously Applied

When a torque load and a radial load are simultaneously applied, calculate the nominal life by obtaining the equivalent radial load using the equation (11) below.

$$P_E = P_C + \frac{4 \cdot T_C \times 10^3}{i \cdot dp \cdot \cos\alpha} \quad \dots\dots(11)$$

P_E : Equivalent radial load (N)

$\cos\alpha$: Contact angle i =Number of rows of balls under a load

Type LBS $\alpha=45^\circ$	$i=3$	Type SLS $\alpha=40^\circ$	$i=3$
Type LT $\alpha=70^\circ$	$i=2$ (LT13 or smaller)	Type LT-X $\alpha=65^\circ$	$i=2$
	$i=3$ (LT16 or greater)		

dp : Ball center-to-center diameter (mm)

(see Table10, Table11, Table12 and Table13 on **A3-24**)

● When a Moment Load is Applied to a Single Nut or Two Nuts in Close Contact with Each Other

Obtain the equivalent radial load using the equation (12) below.

$$P_u = K \cdot M \quad \dots\dots(12)$$

P_u : Equivalent radial load (N)

(with a moment applied)

K : Equivalent Factors

(see Table14 on **A3-27**, Table15 on **A3-28**, Table16 and Table17 on **A3-29**)

M : Applied moment (N·mm)

However, M should be within the range of the static permissible moment.

● When a Moment Load and a Radial Load are Simultaneously Applied

Calculated the nominal life from the sum of the radial load and the equivalent radial load.

● Calculating the Service Life Time

When the nominal life (L_{10}) has been obtained in the equation above, if the stroke length and the number of reciprocations per minute are constant, the service life time is obtained using the equation (13) below.

$$L_h = \frac{L_{10} \times 10^3}{2 \times l_s \times n_1 \times 60} \quad \dots\dots(13)$$

L_h : Service life time (h)
 l_s : Stroke length (m)
 n_1 : Number of reciprocations per minute (min^{-1})

■ f_t : Temperature Factor

If the temperature of the environment surrounding the operating Ball Spline exceeds 100°C , take into account the adverse effect of the high temperature and multiply the basic load ratings by the temperature factor indicated in Fig. 1.

In addition, the Ball Spline must be of a high temperature type.

Note) If the environment temperature exceeds 80°C , high-temperature types of seal and retainer are required. Contact THK for details.

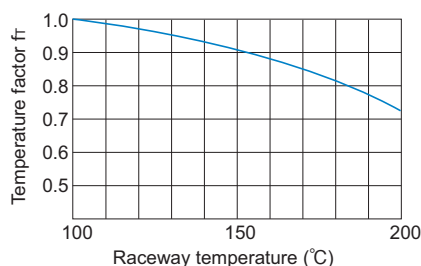

Fig.1 Temperature Factor (f_t)

■ f_c : Contact Factor

When multiple spline nuts are used in close contact with each other, their linear motion is affected by moments and mounting accuracy, making it difficult to achieve uniform load distribution. In such applications, multiply the basic load rating (C) and (C_0) by the corresponding contact factor in Table 8.

Note) If uneven load distribution is expected in a large machine, take into account the respective contact factor indicated in Table 8.

Table 8 Contact Factor (f_c)

Number of spline nuts in close contact with each other	Contact factor f_c
2	0.81
3	0.72
4	0.66
5	0.61
Normal use	1

■ f_w : Load Factor

In general, reciprocating machines tend to experience vibrations or impacts during operation, and it is difficult to accurately determine the vibrations generated during high-speed operation and impacts during frequent starts and stops. When the actual load applied to a ball spline cannot be obtained, or when speed and vibrations have a significant influence, divide the basic dynamic load rating (C) by the corresponding load factor in Table 9, which has been empirically obtained.

Table 9 Load Factor (f_w)

Vibrations/impact	Speed (V)	f_w
Faint	Very low $V \leq 0.25\text{m/s}$	1 to 1.2
Weak	Slow $0.25 < V \leq 1\text{m/s}$	1.2 to 1.5
Medium	Medium $1 < V \leq 2\text{m/s}$	1.5 to 2
Strong	High $V > 2\text{m/s}$	2 to 3.5

[Sectional Shape of the Spline Shaft]

● Spline Shaft for Models SLS, SLS-L and SLF

Table10 Sectional Shape

Unit: mm

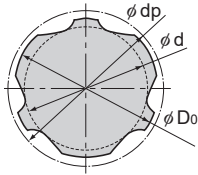

Nominal shaft diameter	25	30	40	50	60	70	80	100
Minor diameter ϕd	21.6	25.8	35.2	44.4	54.0	62.8	71.3	90.0
Major diameter ϕD_0 h7	25	30	40	50	60	70	80	100
Ball center-to-center diameter ϕdp	25.2	30.2	40.6	50.6	61.0	71.0	80.8	101.2

*The minor diameter ϕd must be a value at which no groove is left after machining.

● Spline Shaft for Models LBS, LBST, LBF, LBR, LBH, LBG and LBGT

Table11 Sectional Shape

Unit: mm

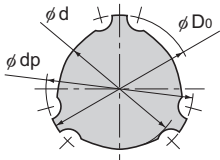

Nominal shaft diameter	15	20	25	30	40	50	60	70	85	100	120	150
Minor diameter ϕd	11.7	15.3	19.5	22.5	31	39	46.5	54.5	67	81	101	130
Outer diameter ϕD_0	14.5	19.7	24.5	29.6	39.8	49.5	60	70	84	99	117	147
Ball center-to-center diameter ϕdp	15	20	25	30	40	50	60	70	85	100	120	150

*The minor diameter ϕd must be a value at which no groove is left after machining.

● Spline Shaft for Models LT, LF, LTR and LTR-A

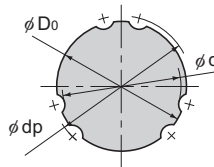
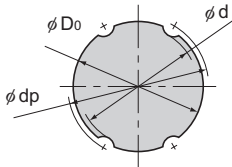

Nominal shaft diameter: 13 mm or less Nominal shaft diameter: 16 mm or more

Table12 Sectional Shape

Unit: mm

Nominal shaft diameter	4	5	6	8	10	13	16	20	25	30	32	40	50	60	80	100
Minor diameter ϕd	3.5	4.5	5	7	8.5	11.5	14.5	18.5	23	28	30	37.5	46.5	56.5	75.5	95
Outer diameter ϕD_0 h7	4	5	6	8	10	13	16	20	25	30	32	40	50	60	80	100
Outer diameter tolerance	0 -0.012		0 -0.015		0 -0.018		0 -0.021			0 -0.025		0 -0.03		0 -0.035		
Ball center-to-center diameter ϕdp	4.6	5.7	7	9.3	11.5	14.8	17.8	22.1	27.6	33.2	35.2	44.2	55.2	66.3	87.9	109.5

*The minor diameter ϕd must be a value at which no groove is left after machining.

● Spline Shaft for Models LT-X, LF-X, LFK-X, and LFH-X

Table13 Sectional Shape

Unit: mm

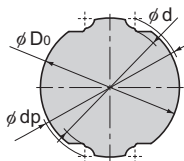

Nominal shaft diameter	4X	5X	6X	8X	10X	13X	16X	20X	25X	30X
Minor diameter ϕd	3.6	4.5	5.4	7	8.6	11.3	13.9	17.9	22.4	27
Major diameter ϕD_0	4	5	6	8	10	13	16	20	25	30
Ball center-to-center diameter ϕdp	4.4	5.5	6.6	8.6	10.7	13.8	17.1	21.1	26.4	31.6

[Calculating the Average Load]

When the load applied on the spline shaft fluctuates according to varying conditions, such as an industrial robot arm traveling forward while holding a workpiece and traveling backward with empty weight, and a machine tool handling various workpieces, this varying load condition must be taken into account in service life calculation.

The average load (P_m) is a constant load under which the service life of an operating Ball Spline with its spline nut receiving a fluctuation load in varying conditions is equivalent to the service life under this varying load condition.

The following is the basic equation.

$$P_m = \sqrt[3]{\frac{1}{L} \cdot \sum_{n=1}^n (P_n^3 \cdot L_n)}$$

P_m : Average Load (N)

P_n : Varying load (N)

L : Total travel distance (mm)

L_n : Distance traveled under P_n (mm)

● When the Load Fluctuates Stepwise

$$P_m = \sqrt[3]{\frac{1}{L} (P_1^3 \cdot L_1 + P_2^3 \cdot L_2 + \dots + P_n^3 \cdot L_n)} \dots\dots\dots (14)$$

P_m : Average Load (N)

P_n : Varying load (N)

L : Total travel distance (m)

L_n : Distance traveled under load P_n (m)

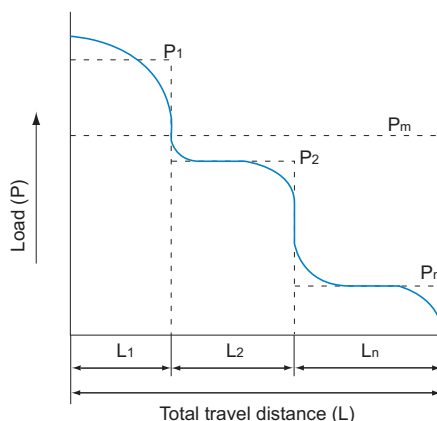

Fig.2

● When the Load Fluctuates Monotonically

$$P_m \doteq \frac{1}{3} (P_{\min} + 2 \cdot P_{\max}) \dots\dots\dots (15)$$

P_{\min} : Minimum load (N)

P_{\max} : Maximum load (N)

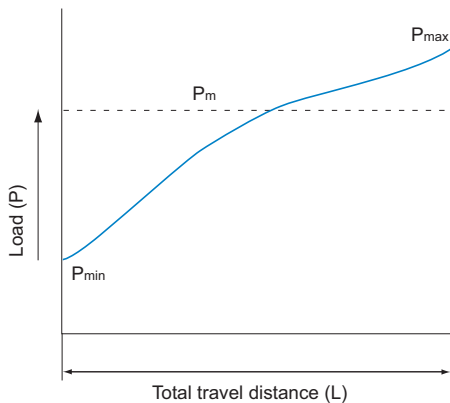

Fig.3

● When the Load Fluctuates Sinusoidally

(a) $P_m \doteq 0.65P_{\max} \dots\dots\dots (16)$

(b) $P_m \doteq 0.75P_{\max} \dots\dots\dots (17)$

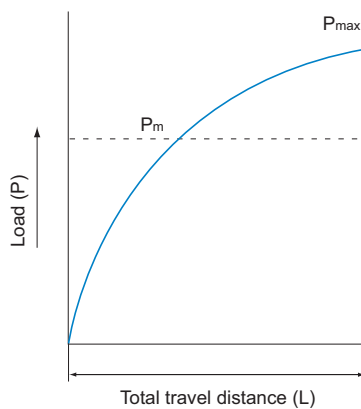
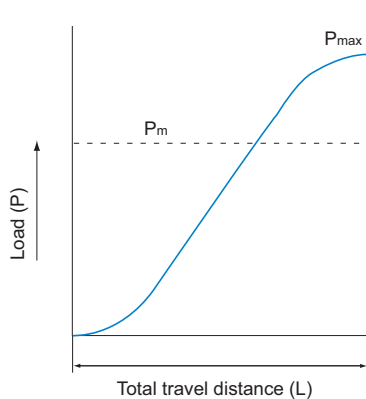

Fig.4

[Equivalent Factor]

Table14 on **A3-27**, Table15 on **A3-28**, Table16 and Table17 on **A3-29** show equivalent radial load factors calculated under a moment load.

● **Table of Equivalent Factors for Ball Spline Models SLS/SLF**

Table14

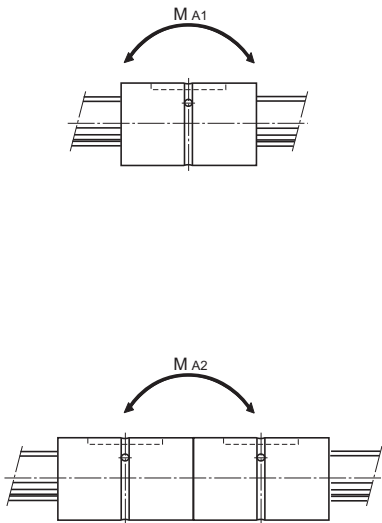

Model No.	Equivalent factor: K	
	Single spline nut	Two spline nuts in close contact with each other
SLS/SLF 25	0.187	0.030
SLS 25L	0.148	0.027
SLS/SLF 30	0.153	0.027
SLS 30L	0.129	0.024
SLS/SLF 40	0.114	0.021
SLS 40L	0.102	0.019
SLS/SLF 50	0.109	0.018
SLS 50L	0.091	0.017
SLS/SLF 60	0.080	0.015
SLS 60L	0.072	0.014
SLS/SLF 70	0.101	0.016
SLS 70L	0.076	0.014
SLS/SLF 80	0.083	0.013
SLS 80L	0.072	0.012
SLS/SLF 100	0.068	0.011
SLS 100L	0.056	0.010

● Table of Equivalent Factors for Ball Spline Model LBS

Table15

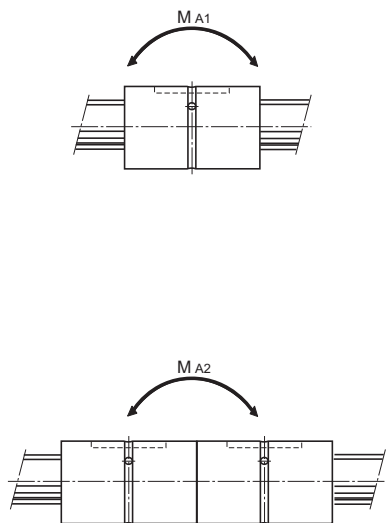

Model No.	Equivalent factor: K	
	Single spline nut	Two spline nuts in close contact with each other
LBS 15	0.22	0.039
LBS 20	0.24	0.03
LBST 20	0.17	0.027
LBS 25	0.19	0.026
LBST 25	0.14	0.023
LBS 30	0.16	0.022
LBST 30	0.12	0.02
LBS 40	0.12	0.017
LBST 40	0.1	0.016
LBS 50	0.11	0.015
LBST 50	0.09	0.014
LBST 60	0.08	0.013
LBS 70	0.1	0.013
LBST 70	0.08	0.012
LBS 85	0.08	0.011
LBST 85	0.07	0.01
LBS 100	0.08	0.009
LBST 100	0.06	0.009
LBST 120	0.05	0.008
LBST 150	0.045	0.006

Note1) Values of equivalent factor K for model LBF are the same as that for model LBS.

Note2) Values of equivalent factor K for models LBR, LBG, LBGT and LBH are the same as that for model LBST.

However the values of model LBF60 are the same as that for model LBST60.

The values of model LBH15 are the same as that for model LBS15.

● Table of Equivalent Factors for Ball Spline Model LT

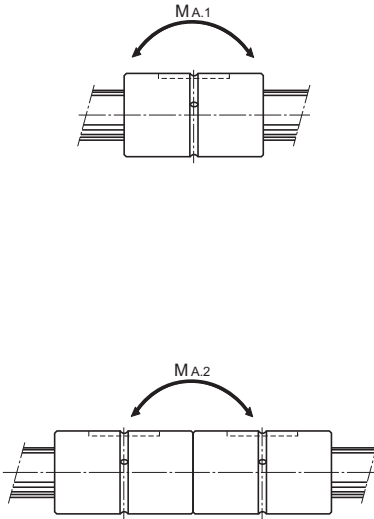

Table16

Model No.	Equivalent factor: K	
	Single spline nut	Two spline nuts in close contact with each other
LT 4	0.65	0.096
LT 5	0.55	0.076
LT 6	0.47	0.06
LT 8	0.47	0.058
LT 10	0.31	0.045
LT 13	0.3	0.042
LT 16	0.19	0.032
LT 20	0.16	0.026
LT 25	0.13	0.023
LT 30	0.12	0.02
LT 40	0.088	0.016
LT 50	0.071	0.013
LT 60	0.07	0.011
LT 80	0.062	0.009
LT100	0.057	0.008

Note) Values of equivalent factor K for models LF, LTR and LTR-A are the same as that for model LT.
However, the equivalent factor for model LTR32 is the same as that for model LT30.

● Table of Equivalent Factors for Ball Spline Model LT-X

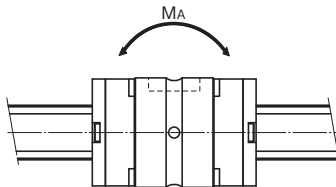

Table17

Model No.	Equivalent factor: K	
	Single spline nut	Two spline nuts in close contact with each other
LT 4X	0.995	0.135
LT 5X	0.980	0.125
LT 5XL	0.430	0.0740
LT 6X	0.660	0.0993
LT 6XL	0.360	0.0633
LT 8X	0.420	0.0626
LT 8XL	0.210	0.0409
LT 10X	0.251	0.0470
LT 13X	0.241	0.0420
LT 16X	0.173	0.0320
LT 20X	0.129	0.0250
LT 25X	0.114	0.0220
LT 30X	0.101	0.0200

Note) The values shown are those for models equipped with seals.

Values of equivalent factor K for model LF-X are the same as that for model LT-X.

Selecting a Preload

A preload on the Ball Spline significantly affects its accuracy, load resistance and rigidity. Therefore, it is necessary to select the most appropriate clearance according to the intended use.

Specific clearance values are standardized for each model, allowing you to select a clearance that meets the conditions.

Clearance in the Rotation Direction

With the Ball Spline, the sum of clearances in the circumferential direction is standardized as the clearance in the rotational direction. For models LBS and LT, which are especially suitable for transmission of rotational torque, clearances in the rotational directions are defined.

Clearance in the rotational direction (BCD)

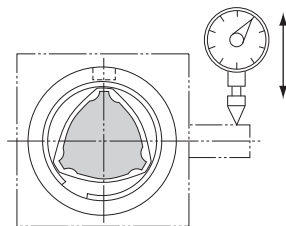
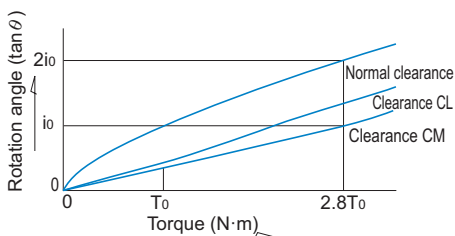

Fig.5 Measurement of Clearance in the Rotational Direction

Preload and Rigidity

Preload is defined as the load preliminarily applied to the ball in order to eliminate angular backlash (clearance in the rotational direction) and increase rigidity. When given a preload, the Ball Spline is capable of increasing its rigidity by eliminating the angular backlash according to the magnitude of the preload. Fig.6 shows the displacement in the rotational direction when a rotational torque is applied.

Thus, the effect of a preload can be obtained up to 2.8 times that of the applied preload. When given the same rotational torque, the displacement when a preload is applied is 0.5 or less of that without a preload. The rigidity with a preload is at least twice greater than that without a preload.



To: Applied preload

Fig.6

Conditions and Guidelines for Selecting of a Preload

Table18 provides guidelines for selecting a clearance in the rotational direction with given conditions of the Ball Spline.

The rotational clearance of the Ball Spline significantly affects the accuracy and rigidity of the spline nut. Therefore, it is essential to select a correct clearance according to the intended use. Generally, the Ball Spline is provided with a preload. When it is used in repeated circular motion or reciprocating straight motion, the Ball Spline is subject to a large vibration impact, and therefore, its service life and accuracy are significantly increased with a preload.

Table18 Guidelines for Selecting a Clearance in the Rotational Direction for the Ball Spline

Clearance in the rotation direction	Condition	Examples of applications
Normal grade (No symbol)	<ul style="list-style-type: none"> Smooth motion with a small force is desired. A torque is always applied in the same direction. 	<ul style="list-style-type: none"> Measuring instruments Automatic drafting machine Geometrical measuring equipment Dynamometer Wire winder Automatic welding machine Main shaft of honing machine Automatic packing machine
Light preload (CL)	<ul style="list-style-type: none"> An overhang load or moment load is present. High positioning repeatability is required. Alternating load is applied. 	<ul style="list-style-type: none"> Industrial robot arm Automatic loaders Guide shaft of automatic coating machine Main shaft of electric discharge machine Guide shaft for press die setting Main shaft of drilling machine
Medium preload (CM)	<ul style="list-style-type: none"> High rigidity is required and vibrations and impact are applied. Receives a moment load with a single spline nut. 	<ul style="list-style-type: none"> Steering shaft of construction vehicle Shaft of spot-welding machine Indexing shaft of automatic lathe tool rest

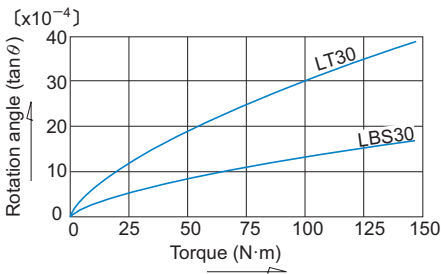

Fig.7 Comparison between LBS and LT for Zero Clearance

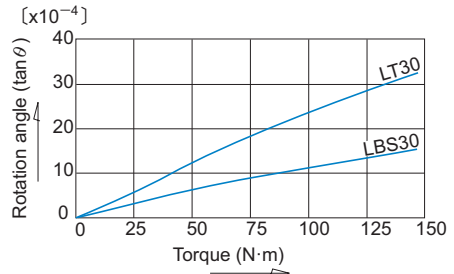

Fig.8 Comparison between LBS and LT for Clearance CL

Table19 Clearance in the Rotational Direction for Models SLS, SLS-L and SLF

Unit: μm

Nominal shaft diameter	Clearance (Symbol)		
	Normal (No Symbol)	Light preload (CL)	Medium preload (CM)
25 30 40	+1 to -2	-2 to -6	-6 to -10
50 60	+2 to -4	-4 to -8	-8 to -12
70 80 100	+4 to -8	-8 to -12	-12 to -20

Table20 Clearance in the Rotational Direction for Models LBS, LBF, LBST, LBR and LBH

Unit: μm

Nominal shaft diameter	Clearance (Symbol)		
	Normal (No Symbol)	Light preload (CL)	Medium preload (CM)
15	-3 to +2	-9 to -3	-15 to -9
20 25 30	-4 to +2	-12 to -4	-20 to -12
40 50 60	-6 to +3	-18 to -6	-30 to -18
70 85	-8 to +4	-24 to -8	-40 to -24
100 120	-10 to +5	-30 to -10	-50 to -30
150	-15 to +7	-40 to -15	-70 to -40

Table21 Clearance in the Rotational Direction for Models LT and LF

Unit: μm

Nominal shaft diameter	Clearance (Symbol)		
	Normal (No Symbol)	Light preload (CL)	Medium preload (CM)
4 5 6 8 10 13	-2 to +1	-6 to -2	—
16 20	-2 to +1	-6 to -2	-9 to -5
25 30	-3 to +2	-10 to -4	-14 to -8
40 50	-4 to +2	-16 to -8	-22 to -14
60 80	-5 to +2	-22 to -12	-30 to -20
100	-6 to +3	-26 to -14	-36 to -24

Table22 Clearance in the Rotational Direction for Models LT-X, LF-X, LFK-X, and LFH-X

Unit: μm

Nominal shaft diameter	Clearance (Symbol)		
	Normal (No Symbol)	Light preload (CL)	Medium preload (CM)
4 5 6 8	-2 to +1	-6 to -2	—
10 13	-2 to +1	-4 to -2	—
16 20	-2 to +1	-5 to -2	-8 to -5
25 30	-3 to +1	-7 to -3	-11 to -7

Point of Selection

Selecting a Preload

Table23 Clearance in the Rotational Direction for Models LBG and LBGT

Unit: μm

Nominal shaft diameter	Clearance (Symbol)		
	Normal (No Symbol)	Light preload (CL)	Medium preload (CM)
20 25 30	-4 to +2	-12 to -4	-20 to -12
40 50 60	-6 to +3	-18 to -6	-30 to -18
70 85	-8 to +4	-24 to -8	-40 to -24

Table24 Clearance in the Rotational Direction for Model LTR

Unit: μm

Nominal shaft diameter	Clearance (Symbol)		
	Normal (No Symbol)	Light preload (CL)	Medium preload (CM)
8 10	-2 to +1	-6 to -2	—
16 20	-2 to +1	-6 to -2	-9 to -5
25 32	-3 to +2	-10 to -4	-14 to -8
40 50	-4 to +2	-16 to -8	-22 to -14
60	-5 to +2	-22 to -12	-30 to -20

Determining the Accuracy

Accuracy Grades

The accuracy of a ball spline is divided into normal grade (No symbol), high accuracy grade (H), or precision grade (P) based on the radial runout of the spline nut diameter in relation to the spline shaft support. The areas measured are shown in Fig.9 and Fig.10.

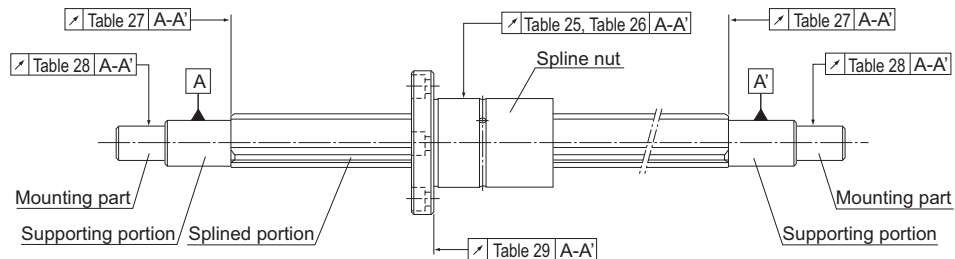

Fig.9 LBS/LBF Accuracy Measurements

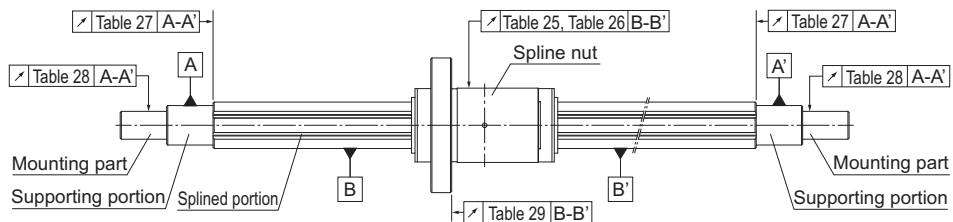

Fig.10 LT/LT-X Accuracy Measurements

Accuracy Standards

Table25 to Table29 show measurement items of the Ball Spline.

Table25 Radial Runout of the Spline Nut Diameter in Relation to the Spline Shaft Support

Unit: μm

Accuracy		Radial runout (max)																							
Nominal shaft diameter		4 to 8 ^{Note}			10			13 to 20			25 to 32			40, 50			60 to 80			85 to 120			150		
Overall spline shaft length (mm)		Normal	High	Precision	Normal	High	Precision	Normal	High	Precision	Normal	High	Precision	Normal	High	Precision	Normal	High	Precision	Normal	High	Precision	Normal	High	Precision
Above	Or less																								
—	200	72	46	26	59	36	20	56	34	18	53	32	18	53	32	16	51	30	16	51	30	16	—	—	—
200	315	133	89	57	83	54	32	71	45	25	58	39	21	58	36	19	55	34	17	53	32	17	—	—	—
315	400	185	126	82	103	68	41	83	53	31	70	44	25	63	39	21	58	36	19	55	34	17	—	—	—
400	500	236	163	108	123	82	51	95	62	38	78	50	29	68	43	24	61	38	21	57	35	19	46	36	19
500	630	—	—	—	151	102	65	112	75	46	88	57	34	74	47	27	65	41	23	60	37	20	49	39	21
630	800	—	—	—	190	130	85	137	92	58	103	68	42	84	54	32	71	45	26	64	40	22	53	43	24
800	1000	—	—	—	—	—	—	170	115	75	124	83	52	97	63	38	79	51	30	69	43	24	58	48	27
1000	1250	—	—	—	—	—	—	—	—	—	151	102	65	114	76	47	90	59	35	76	48	28	63	55	32
1250	1600	—	—	—	—	—	—	—	—	—	190	130	85	139	93	59	106	70	43	86	55	33	80	65	40
1600	2000	—	—	—	—	—	—	—	—	—	—	—	—	173	118	77	128	86	54	99	65	40	100	80	50
2000	2500	—	—	—	—	—	—	—	—	—	—	—	—	—	—	—	156	106	68	117	78	49	125	100	68
2500	3000	—	—	—	—	—	—	—	—	—	—	—	—	—	—	—	190	134	88	143	96	61	150	129	84

Note1) Dimensions in parentheses do not apply to nominal shaft diameter of 4.

Note2) Applicable to models SLS, SLF, LBS, LBST, LBF, LBR, LT and LF.

Note3) The maximum manufacturing length differs by model. For details on the maximum manufacturing length by accuracy grade, see **A3-121**.

Table26 Radial Runout of the Spline Nut Diameter in Relation to the Spline Shaft Support for Models LT-X, LF-X, LFK-X, and LFH-X

Unit: μm

Accuracy		Radial runout (max)														
Nominal shaft diameter		4, 5			6, 8			10			13, 16, 20			25, 30		
Overall spline shaft length (mm)		Normal	High	Precision	Normal	High	Precision	Normal	High	Precision	Normal	High	Precision	Normal	High	Precision
Above	Or less															
—	200	72	46	26	72	46	26	59	36	20	56	34	18	53	32	18
200	315	133*1	—	—	133	89*2	57*3	83	54	32	71	45	25	58	39	21
315	400	—	—	—	171	114	—	103	68	41	83	53	31	70	44	25
400	500	—	—	—	214	—	—	123	82	51	95	62	38	78	50	29
500	630	—	—	—	—	—	—	151	102	—	112	75	46	88	57	34
630	800	—	—	—	—	—	—	190	—	—	137	92	58	103	68	42
800	1000	—	—	—	—	—	—	—	—	—	170	115	75	124	83	52
1000	1250	—	—	—	—	—	—	—	—	—	—	—	—	151	102	65
1250	1600	—	—	—	—	—	—	—	—	—	—	—	—	190	130	85

*1 Except #4. Value is applicable to #5 up to 250 mm. *2 Value is applicable to #6 up to 250 mm. *3 Except #6.

Table27 Axial Runout of the Spline Shaft End Face in Relation to the Spline Shaft Support

Unit: μm

Accuracy	Axial runout (max)		
Nominal shaft diameter	Normal grade (No symbol)	High accuracy grade (H)	Precision Grade (P)
4 5 6 8 10	22	9	6
13 15 16 20	27	11	8
25 30 32	33	13	9
40 50	39	16	11
60 70 80	46	19	13
85 100 120	54	22	15
150	63	25	18

Table28 Radial Runout of the Part-Mounting Surface in Relation to the Spline Shaft Support

Unit: μm

Accuracy	Radial runout (max)		
Nominal shaft diameter	Normal grade (No symbol)	High accuracy grade (H)	Precision Grade (P)
4 5 6 8	33	14	8
10	41	17	10
13 15 16 20	46	19	12
25 30 32	53	22	13
40 50	62	25	15
60 70 80	73	29	17
85 100 120	86	34	20
150	100	40	23

Table29 Axial Runout of the Spline Nut Flange Mounting Surface in Relation to the Spline Shaft Support

Unit: μm

Accuracy	Axial runout (max)		
Nominal shaft diameter	Normal grade (No symbol)	High accuracy grade (H)	Precision Grade (P)
4 5 6 8	27	11	8
10 13	33	13	9
15 16 20 25 30	39	16	11
40 50	46	19	13
60 70 80 85	54	22	15
100	63	25	18

Note) This table does not apply to models LBG, LBGT, LTR and LTR-A.

Point of Selection
Determining the Accuracy

High Torque Caged Ball Spline



Models SLS, SLS-L and SLF

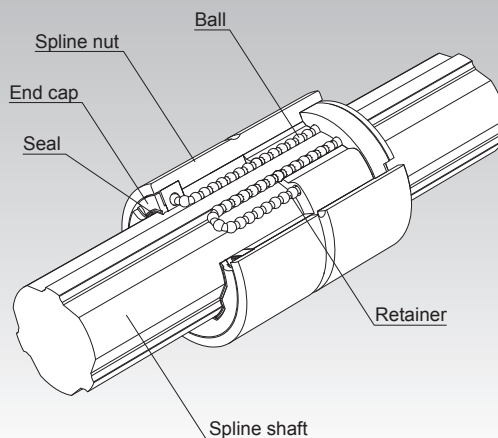

Fig.1 Structure of High Torque Caged Ball Spline

Point of Selection	A3-6
Point of Design	A3-123
Options	A3-126
Model No.	A3-128
Precautions on Use	A3-129
Accessories for Lubrication	A24-1
Mounting Procedure and Maintenance	B3-31
Cross-sectional Characteristics of the Spline Shaft	A3-17
Equivalent factor	A3-27
Clearance in the Rotation Direction	A3-30
Accuracy Standards	A3-35
Maximum Manufacturing Length by Accuracy	A3-121

Structure and Features

The caged-ball technology, developed by bringing together THK's technologies and know-how, is now integrated in the new Ball Spline.

The integration of the ball cage enables the circulating motion of evenly spaced balls and high-speed response to be achieved.

It eliminates collision and mutual friction between balls, and realizes low noise, pleasant running sound and low particle generation. As the grease retention is increased, long-term maintenance-free operation is also achieved.

The high-torque design provides the nut with excellent torsional rigidity. The spline shaft also has enhanced rigidity, thanks to its rounded design.

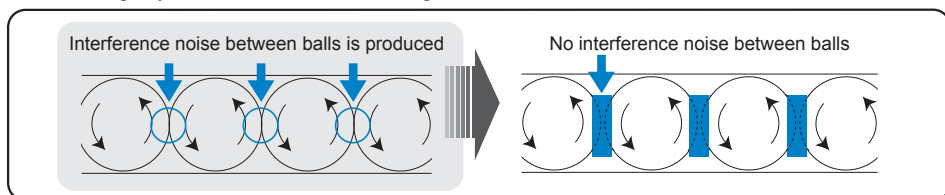

[High-speed Response]

Models SLS/SLF adopt the caged-ball technology to enable the circulating motion of evenly spaced balls to be maintained and high-speed response to be achieved, the cycle time of the machine can be improved.

[Conditions]

Model tested	SLS50
Testing environment	22 to 27.5°C
Stroke	1000mm
Maximum speed	200m/min
Acceleration/deceleration	5G(49m/s ²)
Applied load	Light preload(CL)
Lubricant	THK AFB-LF Grease

Appearance of the test machine
(high-speed durability test)



Appearance of the specimen



[Test results]

No anomaly after travelling 10,000 km

[Improvement on the spline shaft's rigidity]

Redesigning the shape of the conventional high torque type spline shaft to be more circular significantly improves its torsion and flexural rigidity.

Unit: mm

Nominal shaft diameter 25	LBS	SLS
Minor diameter ϕd	19.5	21.6
Major diameter ϕD_0	24.5	25.0
Ball center-to-center diameter ϕdp	25	25.2

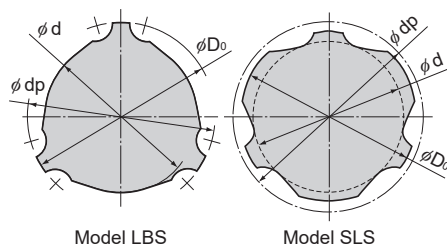

Model LBS

Model SLS

[Low Noise, Pleasant Running Sound and Low Particle Generation]

Models SLS/SLF adopt the caged-ball technology, they eliminate collision and mutual friction between balls, and realize low noise, pleasant running sound and low particle generation.

[Conditions]

Model tested	SLF50/LBF50
Stroke	600mm
Speeds	30,50,100,150m/min
Measuring instrument	Noise level meter

Overview of the test machine

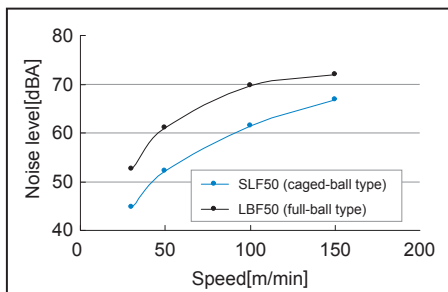
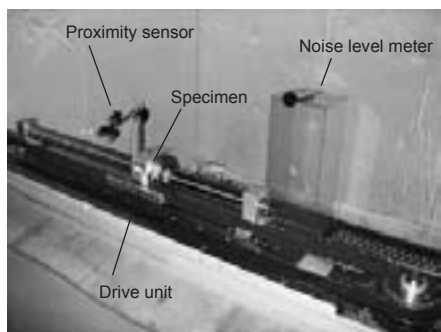

Noise level comparison

[Conditions]

Model tested	SLF50CL+350LP/ LBS50CL+350LP
Maximum speed	30 m/min
Acceleration	2.84 m/s ²
Stroke	200 mm
Amount of air supplied	1 L/200 s
Lubricant	THK AFE-CA Grease
Equipment using the product	Particle counter

Appearance of the test machine

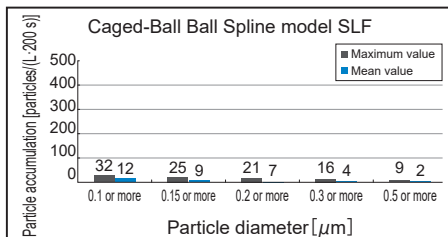
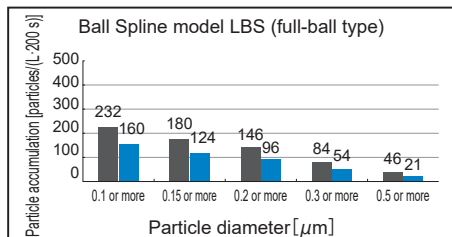
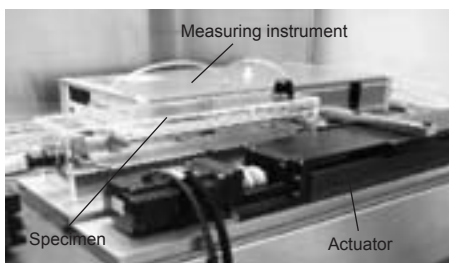

Data on Comparison of Dust Generation

High Torque Caged Ball Spline

[Long-term Maintenance-free Operation]

Models SLS/SLF adopt the caged-ball technology to substantially increase the grease retention, thus achieving long-term maintenance-free operation.

[Smooth Motion (Small Rolling Fluctuation)]

Models SLS/SLF adopt the caged-ball technology and a new circulation method, thus achieving stable and smooth motion with small rolling fluctuation.

[Conditions]

Model tested	SLF50
Speed	10 mm/s
Applied load	Medium preload(CM)
Lubricant	THK AFB-LF Grease

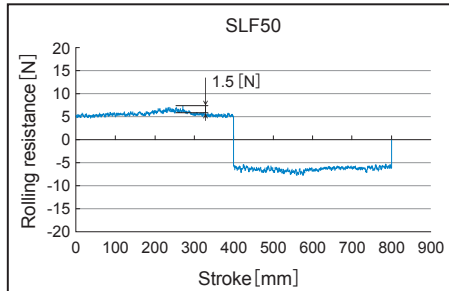

Rolling resistance test

Types and Features

[Types of Spline Nuts]

Cylindrical Type Ball Spline Model SLS (Medium Load Type)

Specification Table⇒ **A3-44**

The circumference of the spline nut is shaped in a straight cylinder.

Using a key, this model can be secured to the housing, or transmit a torque.

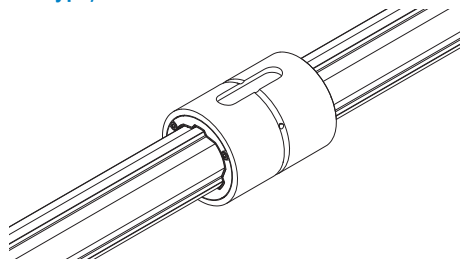

Cylindrical Type Ball Spline Model SLS-L (Heavy Load Type)

Specification Table⇒ **A3-44**

A heavy-load type with the same outer diameter as model SLS and a longer spline nut.

It is optimal in cases where a large torque is applied in a small space, and in cases where an overhang load or moment is applied.

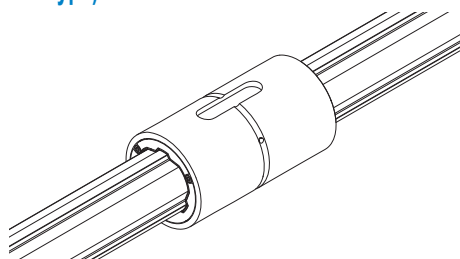

Flanged Type Ball Spline Model SLF

Specification Table⇒ **A3-46**

The housing can be secured with bolts on models equipped with a flange.

This model is easily assembled and can accommodate a shorter housing compared to models with housing secured by a key.

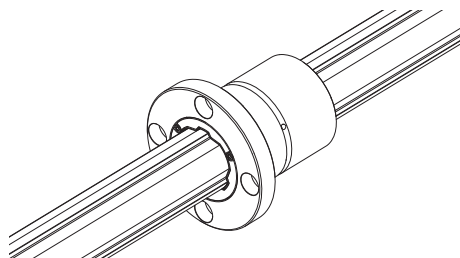

[Types of Spline Shafts]**Precision Solid Spline Shaft (Standard Type)**

The spline shaft is cold-drawn and its raceway is precision ground. It is used in combination with a spline nut.

**Special Spline Shaft**

THK manufactures a spline shaft with thicker ends or thicker middle area through special processing at your request.

**Hollow Spline Shaft (Type K)**

A drawn, hollow spline shaft is available for requirements such as piping, wiring, air-vent and weight reduction.

**Housing Inner-diameter Tolerance**

When fitting the spline nut to the housing, transition fit is normally recommended. If the accuracy of the Ball Spline does not need to be very high, clearance fitting is also acceptable.

Table1 Housing Inner-diameter Tolerance

Housing Inner-diameter Tolerance	General conditions	H7
	When clearance needs to be small	J6

Model SLS

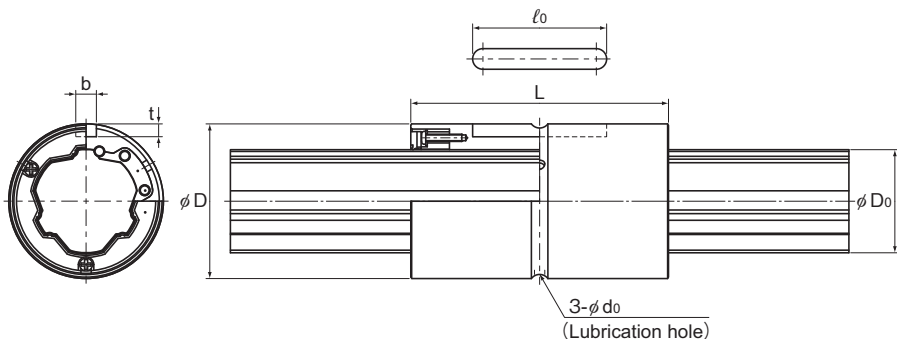

Model No.	Spline nut dimensions							
	Outer diameter		Length		Keyway dimensions			Lubrication hole
	D	Tolerance	L	Tolerance	b H8	t +0.1 0	ℓ_0	d_0
SLS25	37	0	60	0 -0.3	5	3	33	2
SLS25L			70					
SLS30	45	-0.016	70		7	4	41	3
SLS30L			80					
SLS40	60	0	90		10	4.5	55	3
SLS40L			100					
SLS50	75	-0.019	100		15	5	60	4
SLS50L			112					
SLS60	90	0	127		18	6	68	4
SLS60L			140					
SLS70	100	-0.022	110	18	6	68	4	
SLS70L			135					
SLS80	120	0	140	20	7	80	5	
SLS80L			155					
SLS100	140	0	160	28	9	93	5	
SLS100L			185					

Model number coding

2 SLS50 UU CL +700L P K

Model No.

Symbol for clearance
in the rotational direction
(*2)

Symbol for standard hollow spline shaft (*4)
Accuracy symbol (*3)

Contamination protection
accessory symbol (*1)

Overall spline shaft length (*5)
(in mm)

Number of spline nuts on one shaft (no symbol for one nut)

(*1) See **A3-126**. (*2) See **A3-30**. (*3) See **A3-35**. (*4) See **A3-48**. (*5) See **A3-121**.

High Torque Caged Ball Spline

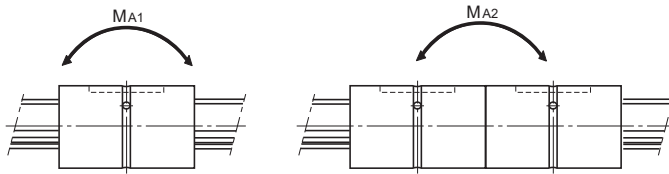

Unit: mm

	Basic torque rating		Basic load rating		Static permissible moment		Mass	
	C _T N·m	C _{0T} N·m	C kN	C ₀ kN	M _{A1} N·m	M _{A2} N·m	Spline Nut kg	Spline shaft kg/m
	219.9	306.8	18.2	22.5	136	851	0.15	3.51
	261.9	394.5	21.7	29	220	1203	0.18	
	366.5	513.3	25.4	31.5	233	1341	0.3	5.05
	416.4	616	28.9	37.8	330	1803	0.34	
	818.9	1135.4	42.8	52.5	520	2801	0.69	9.18
	890	1277.3	46.5	59.1	652	3529	0.79	
	1373.4	1783.1	57.6	66.2	687	4156	1.3	14.45
	1571.2	2165.2	65.9	80.4	996	5349	1.47	
	2506.7	3321	87.8	103	1452	7733	2.25	21.23
	2723.2	3736.2	95.3	115.8	1820	9570	2.5	
	2986.3	3474.7	89.7	92.5	1038	6392	2.13	28.57
	3708.4	4738.2	111.4	126.1	1867	10135	2.71	
	4664.6	5477.4	122.8	127.7	1739	11482	4.22	37.49
	5195.3	6390.4	136.8	148.9	2327	14491	4.77	
	8922.3	10211.6	188.2	190.7	3155	19118	5.2	58.97
	10424.4	12764.6	219.8	238.4	4816	26463	6.22	

Model SLF

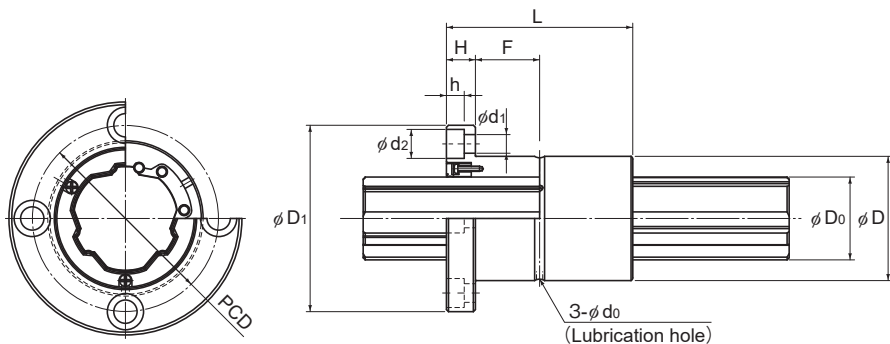

Model No.	Spline nut dimensions									
	Outer diameter		Length		Flange diameter		H	F	Lubrication hole d_o	PCD
	D	Tolerance	L	Tolerance	D_1	Tolerance				
SLF25	37	0	60	0 -0.3	60	0 -0.2	9	21	2	47
SLF30	45	-0.016	70		70		10	25	3	54
SLF40	60	0 -0.019	90		90		14	31	3	72
SLF50	75		100		113	16	34	4	91	
SLF60	90	0 -0.022	127	0 -0.4	129	0 -0.3	18	45.5	4	107
SLF70	100		110		142		20	35	4	117
SLF80	120		140		168	22	48	5	138	
SLF100	140	0 -0.025	160		195	0 -0.4	25	55	5	162

Model number coding

2 SLF50 UU CL +700L P K

Model No.

Symbol for clearance
in the rotational direction
(*2)

Symbol for standard hollow spline shaft (*4)
Accuracy symbol (*3)

Contamination protection
accessory symbol (*1)

Overall spline shaft length (*5)
(in mm)

Number of spline nuts on one shaft (no symbol for one nut)

(*1) See **A3-126**. (*2) See **A3-30**. (*3) See **A3-35**. (*4) See **A3-48**. (*5) See **A3-121**.

High Torque Caged Ball Spline

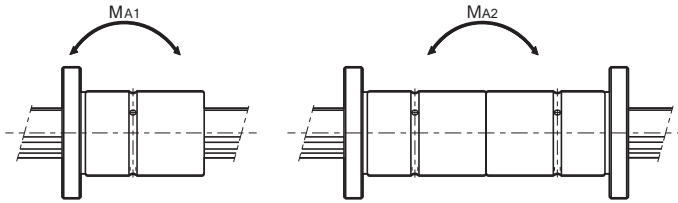

Unit: mm

	Mounting hole $d_1 \times d_2 \times h$	Basic torque rating		Basic load rating		Static permissible moment		Mass	
		C_T N·m	C_{OT} N·m	C kN	C_0 kN	M_{A1} N·m	M_{A2} N·m	Spline Nut kg	Spline shaft kg/m
	5.5×9.5×5.4	219.9	306.8	18.2	22.5	136	851	0.26	3.51
	6.6×11×6.5	366.5	513.3	25.4	31.5	233	1341	0.45	5.05
	9×14×8.6	818.9	1135.4	42.8	52.5	520	2801	1.06	9.18
	11×17.5×11	1373.4	1783.1	57.6	66.2	687	4156	1.9	14.45
	11×17.5×11	2506.7	3321	87.8	103	1452	7733	3.08	21.23
	14×20×13	2986.3	3474.7	89.7	92.5	1038	6392	3.25	28.57
	16×23×15.2	4664.6	5477.4	122.8	127.7	1739	11482	5.82	37.49
	18×26×17.5	8922.3	10211.6	188.2	190.7	3155	19118	7.66	58.97

Spline Shaft

Spline shafts are divided in shape into precision solid spline shaft, special spline shaft and hollow spline shaft (type K), as described on **A3-43**.

Since production of a spline shaft with a specific shape is performed at your request, provide a drawing of the desired shaft shape when asking an estimate or placing an order.

[Sectional Shape of the Spline Shaft]

Table2 shows the sectional shape of a spline shaft. If the spline shaft ends need to be cylindrical, the minor diameter (ϕd) value should not be exceeded if possible.

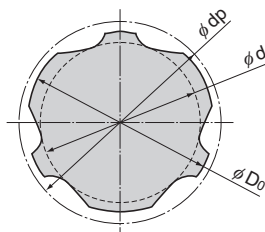

Table2 Sectional Shape of the Spline Shaft

Unit: mm

Nominal shaft diameter	25	30	40	50	60	70	80	100
Minor diameter ϕd	21.6	25.8	35.2	44.4	54	62.8	71.3	90
Major diameter ϕD_0 h7	25	30	40	50	60	70	80	100
Ball center-to-center diameter ϕdp	25.2	30.2	40.6	50.6	61	71	80.8	101.2
Mass(kg/m)	3.51	5.05	9.18	14.45	21.23	28.57	37.49	58.97

*The minor diameter ϕd must be a value at which no groove is left after machining.

[Hole Shape of the Standard Hollow Type Spline Shaft]

Table3 shows the hole shape of the standard hollow type spline shaft. Use this table when a requirement such as piping, wiring, air-vent or weight reduction needs to be met.

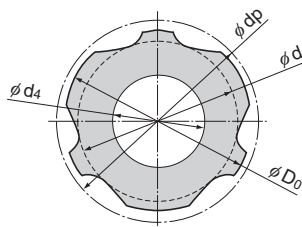

Table3 Sectional Shape of the Standard Hollow Type Spline Shaft

Unit: mm

Nominal shaft diameter	25	30	40	50	60	70	80	100
Minor diameter ϕd	21.6	25.8	35.2	44.4	54	62.8	71.3	90
Major diameter ϕD_0 h7	25	30	40	50	60	70	80	100
Ball center-to-center diameter ϕdp	25.2	30.2	40.6	50.6	61	71	80.8	101.2
Hole diameter(ϕd_4)	12	16	22	25	32	—	52.5	67.5
Mass(kg/m)	2.62	3.47	6.19	10.59	14.9	—	20.48	30.85

*The minor diameter ϕd must be a value at which no groove is left after machining.

[Chamfering of the Spline Shaft Ends]

To facilitate the insertion of the spline shaft into a spline nut, the shaft ends are normally chamfered with the dimensions indicated below unless otherwise specified.

The ends are chamfered whether they are used, such as with stepped, tapped, or drilled ends, or not used, such as with cantilevered supports.

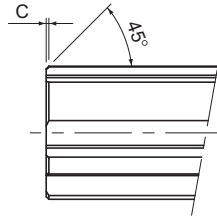

SLS25 to 100

Table 4 Chamfer Dimensions of Spline Shaft Ends

Unit: mm

Nominal shaft diameter	25	30	40	50	60	70	80	100
Chamfer C	0.5	0.5	1	1	2	2	2	2

[Length of the Incomplete Area of a Special Spline Shaft]

If any part of the spline shaft is thicker than the minor diameter (ϕd), an area with incomplete splines is required to secure a recess for grinding. The relationship between the flange diameter (ϕdf) and the length of incomplete splines (S) is shown in Table 5.

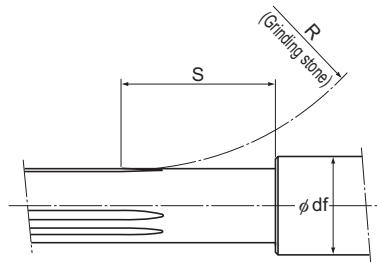

Table 5 Length of Incomplete Spline Area: S

Unit: mm

Flange diameter ϕdf	Nominal shaft diameter										
	25	30	35	40	50	60	80	100	120	140	160
25	41	54	63	72	—	—	—	—	—	—	—
30	—	44	56	65	80	—	—	—	—	—	—
40	—	—	—	46	66	81	104	—	—	—	—
50	—	—	—	—	48	69	94	114	—	—	—
60	—	—	—	—	—	49	83	105	123	—	—
70	—	—	—	—	—	—	70	96	116	131	—
80	—	—	—	—	—	—	55	86	108	125	—
100	—	—	—	—	—	—	—	58	88	109	126

Accessories

Ball Spline models SLS and SLS-L are provided with a standard key as indicated in Table6.

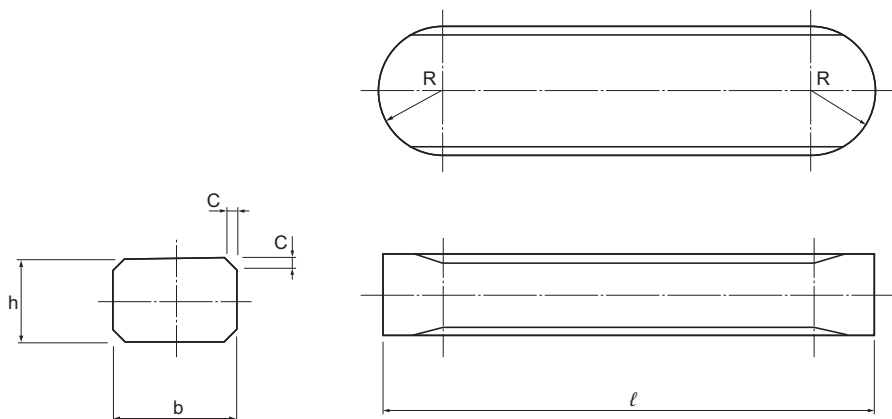

Table6 Standard Keys for Models SLS and SLS-L

Unit: mm

Nominal shaft diameter	Width b		Height h		Length ℓ		R	C
		Tolerance(p7)		Tolerance(h9)		Tolerance(h12)		
SLS 25 SLS 25L	5	+0.024 +0.012	5	0 -0.030	33	0 -0.250	2.5	0.5
SLS 30 SLS 30L	7	+0.030 +0.015	7	0 -0.036	41	0 -0.300	3.5	
SLS 40 SLS 40L	10		8		55		5	0.8
SLS 50 SLS 50L	15	10	60		7.5			
SLS 60 SLS 60L	18	+0.036 +0.018	12	0 -0.043	68	0 -0.350	9	1.2
SLS 70 SLS 70L					13		80	
SLS 80 SLS 80L	20	+0.043 +0.022	18					
SLS 100 SLS 100L	28							

High Torque Caged Ball Spline

Ball Spline

High Torque Type Ball Spline

Models LBS, LBST, LBF, LBR and LBH

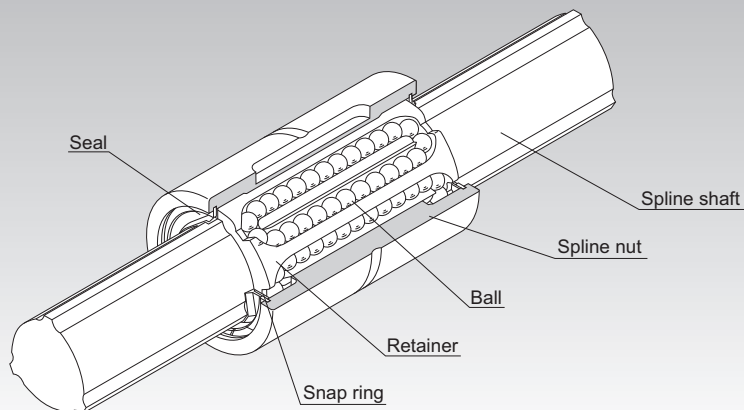

Fig.1 Structure of High Torque Type Ball Spline Model LBS

Point of Selection **A3-6**

Point of Design **A3-123**

Options **A3-126**

Model No. **A3-128**

Precautions on Use **A3-129**

Accessories for Lubrication **A24-1**

Mounting Procedure and Maintenance **B3-31**

Cross-sectional Characteristics of the Spline Shaft **A3-17**

Equivalent factor **A3-27**

Clearance in the Rotation Direction **A3-30**

Accuracy Standards **A3-35**

Maximum Manufacturing Length by Accuracy **A3-121**

Structure and Features

With the high torque type Ball Spline, the spline shaft has three crests positioned equidistantly at 120° , and along both sides of each crest, two rows of balls (six rows in total) are arranged so as to hold the crest, as shown in Fig.1.

The raceways are precision ground into R-shaped grooves whose diameters are approximate to the ball diameter. When a torque is generated from the spline shaft or the spline nut, the three rows of balls on the load-bearing side evenly receive the torque, and the center of rotation is automatically determined. When the rotation reverses, the remaining three rows of balls on the unloaded side receive the torque.

The rows of balls are held in a retainer incorporated in the spline nut so that they smoothly roll and circulate. With this design, balls will not fall even if the spline shaft is removed from the nut.

[No Angular Backlash]

With the high torque type Ball Spline, a single spline nut provides a preload to eliminate angular backlash and increase the rigidity.

Unlike conventional ball splines with circular-arc groove or Gothic-arch groove, the high torque type Ball Spline eliminates the need for twisting two spline nuts to provide a preload, thus allowing compact design to be achieved easily.

[High Rigidity and Accurate Positioning]

Since this model has a large contact angle and provides a preload from a single spline nut, the initial displacement is minimal and high rigidity and high positioning accuracy are achieved.

[High-speed Motion, High-speed Rotation]

Adoption of a structure with high grease retention and a rigid retainer enables the ball spline to operate over a long period with grease lubrication even in high-speed straight motion. Since the distance in the radius direction is almost uniform between the loaded balls and the unloaded balls, the balls are little affected by the centrifugal force and smooth straight motion is achieved even during high-speed rotation.

[Compact Design]

Unlike conventional ball splines, unloaded balls do not circulate on the outer surface of the spline nut with this model. As a result, the outer diameter of the spline nut is reduced and a space-saving and compact design is achieved.

[Ball Retaining Type]

Use of a retainer prevents the balls from falling even if the spline shaft is pulled out of the spline nut.

[Can be Used as a Linear Bushing for Heavy Loads]

Since the raceways are machined into R grooves whose diameter is almost equal to the ball diameter, the contact area of the ball is large and the load capacity is large also in the radial direction.

[Double, Parallel Shafts can be Replaced with a Single Shaft]

Since a single shaft is capable of receiving a load in the torque direction and the radial direction, double shafts in parallel configuration can be replaced with a single-shaft configuration. This allows easy installation and achieves space-saving design.

Applications

The high torque type Ball Spline is a reliable straight motion system used in a wide array of applications such as the columns and arms of industrial robot, automatic loader, transfer machine, automatic conveyance system, tire forming machine, spindle of spot welding machine, guide shaft of high-speed automatic coating machine, riveting machine, wire winder, work head of electric discharge machine, spindle drive shaft of grinding machine, speed gears and precision indexing shaft.

Types and Features

[Types of Spline Nuts]

Cylindrical Type Ball Spline Model LBS (Medium Load Type)

Specification Table⇒ [A 3-58](#)

The most compact type with a straight cylindrical spline nut. When transmitting a torque, a key is driven into the body.

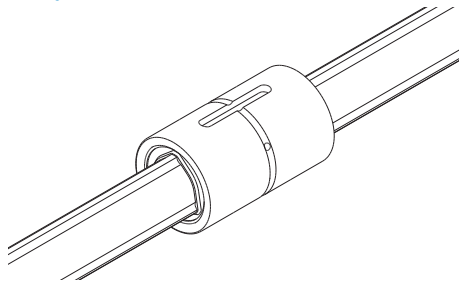

Cylindrical Type Ball Spline Model LBST (Heavy Load Type)

Specification Table⇒ [A 3-60](#)

A heavy load type that has the same spline nut diameter as model LBS, but has a longer spline nut length. It is optimal for locations where the space is small, a large torque is applied, and an overhang load or moment load is applied.

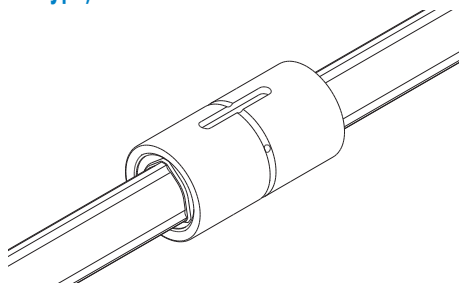

Flanged Type Ball Spline Model LBF

Specification Table⇒ [A 3-62](#)

The spline nut can be attached to the housing via the flange, making assembly simple. It is optimal for locations where the housing may be deformed if a keyway is machined on its surface, and where the housing width is small.

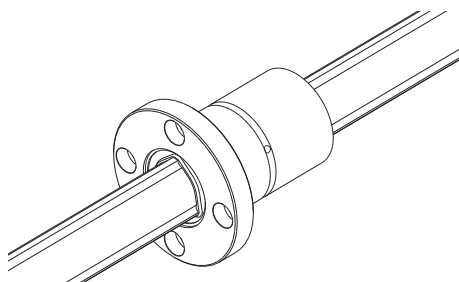

Flanged Type Ball Spline Model LBR

Specification Table⇒**A3-64**

Based on the heavy load type model LBST, this model has a flange in the central area, making itself optimal for locations under a moment load such as arms of industrial robots.

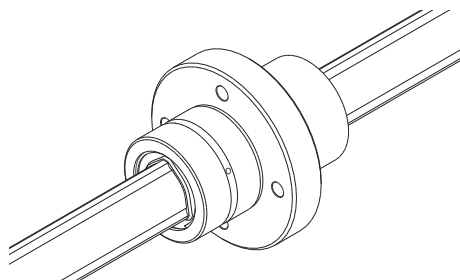

Rectangular Type Ball Spline Model LBH

Specification Table⇒**A3-66**

Its rigid rectangular spline nut does not require a housing and can be directly mounted on the machine body. Thus, a compact, highly rigid linear guide system is achieved.

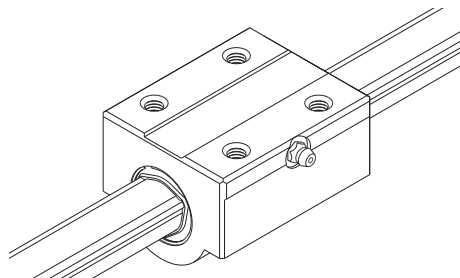

[Types of Spline Shafts]**Precision Solid Spline Shaft (Standard Type)**

The spline shaft is cold-drawn and its raceway is precision ground. It is used in combination with a spline nut.

**Special Spline Shaft**

THK manufactures a spline shaft with thicker ends or thicker middle area through special processing at your request.

**Hollow Spline Shaft (Type K)**

A drawn, hollow spline shaft is available for requirements such as piping, wiring, air-vent and weight reduction.

**Housing Inner-diameter Tolerance**

When fitting the spline nut to the housing, transition fit is normally recommended. If the accuracy of the Ball Spline does not need to be very high, clearance fitting is also acceptable.

Table1 Housing Inner-diameter Tolerance

Housing Inner-diameter Tolerance	General conditions	H7
	When clearance needs to be small	J6

Model LBS (Medium Load Type)

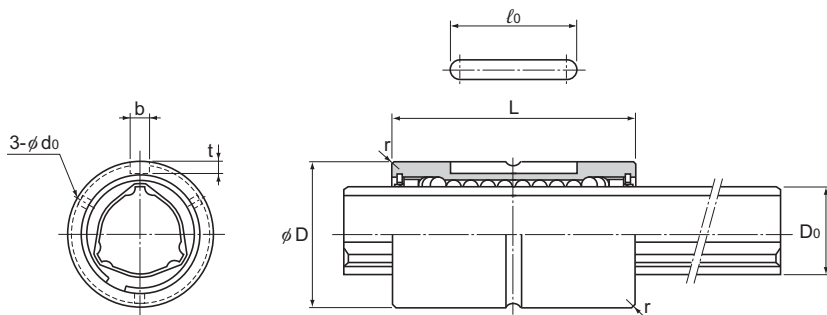

Model No.	Spline nut dimensions											
	Outer diameter		Length		L ₂	L ₃	D ₂	Keyway dimensions			r	C
	D	Tolerance	L	Tolerance				b H8	t +0.1 0	ℓ ₀		
LBS 15	23	⁰ -0.013	40	⁰ -0.2	—	—	—	3.5	2	20	0.5	—
○● LBS 20	30	⁰ -0.016	50	⁰ -0.3	—	—	—	4	2.5	26	0.5	—
○● LBS 25	37		60		—	—	—	5	3	33	0.5	—
○● LBS 30	45	70	—		—	—	7	4	41	1	—	
○● LBS 40	60	⁰ -0.019	90		—	—	—	10	4.5	55	1	—
○● LBS 50	75	100	—		—	—	15	5	60	1.5	—	
○● LBS 70	100	⁰ -0.022	110	⁰ -0.4	—	—	—	18	6	68	2	—
○● LBS 85	120	140	—		—	—	20	7	80	2.5	—	
○● LBS 100	140	⁰ -0.025	160		—	—	—	28	9	93	3	—

Note) ○: Model numbers able to handle high temperatures (metal retainers: operating temperature up to 100°C)
Compatible model numbers: LBS20 to 100

(Example) LBS20 A CL+500L H

High temperature symbol

- : Model numbers compatible with felt seals. Compatible model numbers: LBS20 to 100
Felt seals cannot be attached to ball spline models using metal retainers.
When equipping felt seals, the length dimensions of the nuts will change.

Model number coding

2 LBS40 UU CL +1000L P K

Model No.

Symbol for clearance
in the rotational direction
(*2)

Accuracy symbol
(*3)

Symbol for spline shaft (*4)

Number of spline nuts
on one shaft
(no symbol for one nut)

Contamination protection
accessory symbol
(*1)

Overall spline shaft length (*5)
(in mm)

(*1) See **A3-126**. (*2) See **A3-30**. (*3) See **A3-35**. (*4) See **A3-69**. (*5) See **A3-121**.

High Torque Type Ball Spline

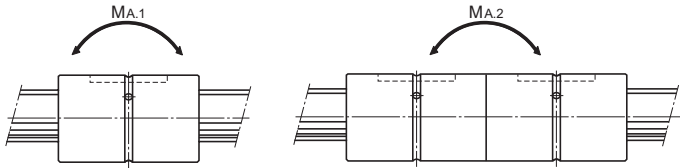

Unit: mm

	Lubrication hole d_0	Spline shaft outer diameter		Basic torque rating		Basic load rating (radial)		Static permissible moment		Mass	
		D_0	d_s	C_T N·m	C_{OT} N·m	C kN	C_0 kN	M_{A1}^{**} N·m	M_{A2}^{**} N·m	Spline Nut kg	Spline shaft kg/m
	2	14.5	—	30.4	74.5	4.4	8.4	25.4	185	0.06	1
	2	19.7	—	74.5	160	7.8	14.9	60.2	408	0.14	1.8
	2	24.5	—	154	307	13	23.5	118	760	0.25	2.7
	3	29.6	—	273	538	19.3	33.8	203	1270	0.44	3.8
	3	39.8	—	599	1140	31.9	53.4	387	2640	1	6.8
	4	49.5	—	1100	1940	46.6	73	594	4050	1.7	10.6
	4	70	—	2190	3800	66.4	102	895	6530	3.1	21.3
	5	84	—	3620	6360	90.5	141	2000	12600	5.5	32
	5	99	—	5190	12600	126	237	3460	20600	9.5	45

Note) M_{A1} indicates the permissible moment value in the axial direction when a single spline nut is used.

M_{A2} indicates the allowable moment load value in the axial direction when using two spline nuts in contact with each other.

For details on the maximum lengths of ball spline shafts by accuracy, please see **A3-121**.

Model LBST (Heavy Load Type)

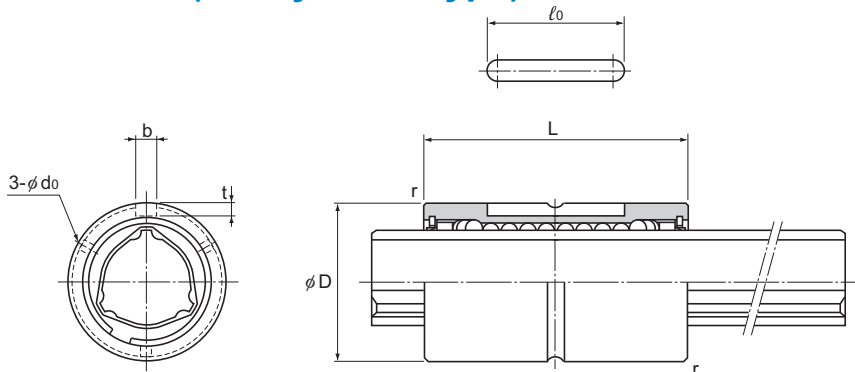

Model No.	Spline nut dimensions								
	Outer diameter		Length		Keyway dimensions			r	Lubrication hole d ₀
	D	Tolerance	L	Tolerance	b H8	t +0.1 0	ℓ ₀		
○● LBST 20	30	0 -0.016	60	0 -0.2	4	2.5	26	0.5	2
○● LBST 25	37		70		5	3	33	0.5	2
○● LBST 30	45	0 -0.019	80	0 -0.3	7	4	41	1	3
○● LBST 40	60		100		10	4.5	55	1	3
○● LBST 50	75	0 -0.022	112	0 -0.4	15	5	60	1.5	4
○ LBST 60	90		127		18	6	68	1.5	4
○● LBST 70	100	0 -0.025	135	0 -0.5	18	6	68	2	4
○● LBST 85	120		155		20	7	80	2.5	5
○● LBST 100	140	0 -0.029	175	0 -0.5	28	9	93	3	5
○ LBST 120	160		200		28	9	123	3.5	6
○ LBST 150	205		250		32	10	157	3.5	6

Note) ○: indicates model numbers for which high temperature types are available (with metal retainer; service temperature: up to 100°C).

(Example) LBST25 A CM+400L H

High temperature symbol

●: indicates model numbers for which felt seal types are available (see **A3-126**).

A felt seal cannot be attached to Ball Spline models using metal retainer.

Model number coding

2 LBST50 UU CM +800L H K

Model No.

Symbol for clearance
in the rotational direction
(*2)

Accuracy symbol
(*3)

Symbol for spline shaft (*4)

Number of spline nuts
on one shaft
(no symbol for one nut) (*1)

Contamination protection
accessory symbol (*1)

Overall spline shaft length (*5)
(in mm)

(*1) See **A3-126**. (*2) See **A3-30**. (*3) See **A3-35**. (*4) See **A3-69**. (*5) See **A3-121**.

High Torque Type Ball Spline

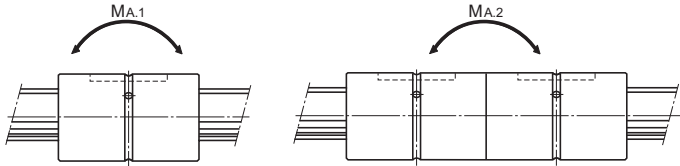

Unit: mm

	Basic torque rating		Basic load rating (radial)		Static permissible moment		Mass	
	C_T N·m	C_{OT} N·m	C kN	C_o kN	M_{A1}^{**} N·m	M_{A2}^{**} N·m	Spline Nut kg	Spline shaft kg/m
	90.2	213	9.4	20.1	103	632	0.17	1.8
	176	381	14.9	28.7	171	1060	0.29	2.7
	312	657	22.5	41.4	295	1740	0.5	3.8
	696	1420	37.1	66.9	586	3540	1.1	6.8
	1290	2500	55.1	94.1	941	5610	1.9	10.6
	1870	3830	66.2	121	1300	8280	3.3	15.6
	3000	6090	90.8	164	2080	11800	3.8	21.3
	4740	9550	119	213	3180	17300	6.1	32
	6460	14400	137	271	4410	25400	10.4	45
	8380	19400	148	306	5490	32400	12.9	69.5
	13900	32200	196	405	8060	55400	28	116.6

Note) M_{A1}^{**} indicates the permissible moment value in the axial direction when a single spline nut is used, as shown in the figure above.

M_{A2}^{**} indicates the permissible moment value in the axial direction when two spline nuts in close contact with each other are used, as shown in the figure above.

For details on the maximum lengths of ball spline shafts by accuracy, please see **A3-121**.

Model LBF (Medium Load Type)

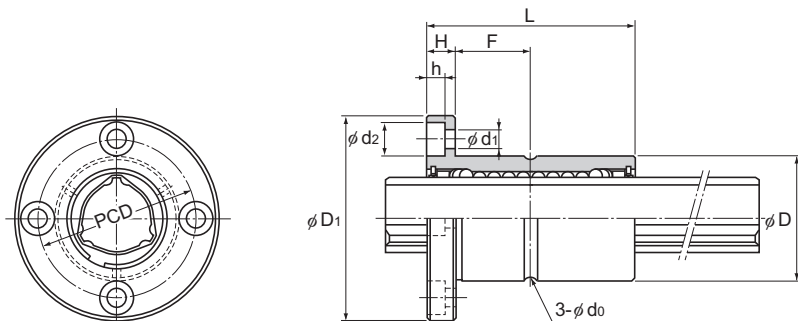

Model No.	Spline nut dimensions									
	Outer diameter		Length		Flange diameter		H	F	Lubrication hole d _o	PCD
	D	Tolerance	L	Tolerance	D ₁	Tolerance				
LBF 15	23	$\begin{matrix} 0 \\ -0.013 \end{matrix}$	40	$\begin{matrix} 0 \\ -0.2 \end{matrix}$	43	$\begin{matrix} 0 \\ -0.2 \end{matrix}$	7	13	2	32
○● LBF 20	30	$\begin{matrix} 0 \\ -0.016 \end{matrix}$	50	$\begin{matrix} 0 \\ -0.3 \end{matrix}$	49		7	18	2	38
○● LBF 25	37		60		60		9	21	2	47
○● LBF 30	45		70		70	10	25	3	54	
○● LBF 40	57	$\begin{matrix} 0 \\ -0.019 \end{matrix}$	90	$\begin{matrix} 0 \\ -0.3 \end{matrix}$	90	$\begin{matrix} 0 \\ -0.3 \end{matrix}$	14	31	3	70
○● LBF 50	70		100		108		16	34	4	86
○ LBF 60	85		127		124		18	45.5	4	102
○● LBF 70	95	$\begin{matrix} 0 \\ -0.022 \end{matrix}$	110	$\begin{matrix} 0 \\ -0.4 \end{matrix}$	142	$\begin{matrix} 0 \\ -0.4 \end{matrix}$	20	35	4	117
○● LBF 85	115		140		168		22	48	5	138
○● LBF 100	135		160		195		25	55	5	162

Note) ○: indicates model numbers for which high temperature types are available (with metal retainer; service temperature: up to 100°C).

(Example) LBF20 A CL+500L H

High temperature symbol

- : indicates model numbers for which felt seal types are available (see **A3-126**).
A felt seal cannot be attached to Ball Spline models using metal retainer.

Model number coding

2 LBF20 DD CL +900L P K

Model No.

Symbol for clearance
in the rotational direction
(*2)

Accuracy symbol
(*3)

Symbol for spline shaft (*4)

Number of spline nuts
on one shaft
(no symbol for one nut) (*1)

Contamination protection
accessory symbol

Overall spline shaft length (*5)
(in mm)

(*1) See **A3-126**. (*2) See **A3-30**. (*3) See **A3-35**. (*4) See **A3-69**. (*5) See **A3-121**.

High Torque Type Ball Spline

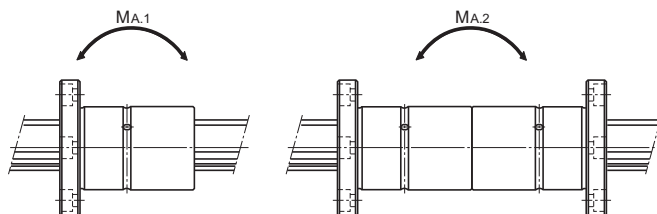

Unit: mm

Mounting hole $d_1 \times d_2 \times h$		Basic torque rating		Basic load rating (radial)		Static permissible moment		Mass	
		C_T N·m	C_{DT} N·m	C kN	C_D kN	M_{A1}^{**} N·m	M_{A2}^{**} N·m	Spline Nut kg	Spline shaft kg/m
	4.5×8×4.4	30.4	74.5	4.4	8.4	25.4	185	0.11	1
	4.5×8×4.4	74.5	160	7.8	14.9	60.2	408	0.2	1.8
	5.5×9.5×5.4	154	307	13	23.5	118	760	0.36	2.7
	6.6×11×6.5	273	538	19.3	33.8	203	1270	0.6	3.8
	9×14×8.6	599	1140	31.9	53.4	387	2640	1.2	6.8
	11×17.5×11	1100	1940	46.6	73	594	4050	1.9	10.6
	11×17.5×11	1870	3830	66.2	121	1300	8280	3.5	15.6
	14×20×13	2190	3800	66.4	102	895	6530	3.6	21.3
	16×23×15.2	3620	6360	90.5	141	2000	12600	6.2	32
	18×26×17.5	5910	12600	126	237	3460	20600	11	45

Note) M_{A1}^{**} indicates the permissible moment value in the axial direction when a single spline nut is used, as shown in the figure above.

M_{A2}^{**} indicates the permissible moment value in the axial direction when two spline nuts in close contact with each other are used, as shown in the figure above.

For details on the maximum lengths of ball spline shafts by accuracy, please see **A3-121**.

Model LBR

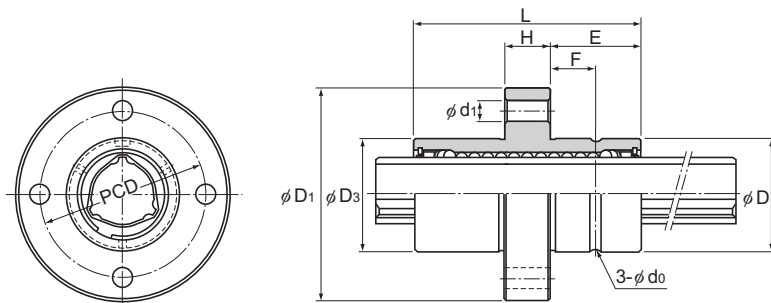

Model No.	Spline nut dimensions								
	Outer diameter		Outer diameter D ₃	Length		Flangediameter D ₁	H	E	PCD
	D	Tolerance		L	Tolerance				
LBR 15	25	$\begin{matrix} 0 \\ -0.013 \end{matrix}$	25.35	40	$\begin{matrix} 0 \\ -0.2 \end{matrix}$	45.4	9	15.5	34
○● LBR 20	30	$\begin{matrix} 0 \\ -0.016 \end{matrix}$	30.35	60	$\begin{matrix} 0 \\ -0.3 \end{matrix}$	56.4	12	24	44
○● LBR 25	40		40.35	70		70.4	14	28	54
○● LBR 30	45		45.4	80		75.4	16	32	61
○● LBR 40	60	$\begin{matrix} 0 \\ -0.019 \end{matrix}$	60.4	100		96.4	18	41	78
○● LBR 50	75	75.4	112	112.4		20	46	94	
○ LBR 60	90	$\begin{matrix} 0 \\ -0.022 \end{matrix}$	90.5	127		134.5	22	52.5	112
○● LBR 70	95		95.6	135	140.6	24	55.5	117	
○● LBR 85	120		120.6	155	170.6	26	64.5	146	
○● LBR 100	140	$\begin{matrix} 0 \\ -0.025 \end{matrix}$	140.6	175	0	198.6	34	70.5	170

Note) ○: indicates model numbers for which high temperature types are available (with metal retainer; service temperature: up to 100°C).

(Example) LBR40 $\overset{\text{A}}{\text{C}}\text{M}+600\text{LH}$

High temperature symbol

- : indicates model numbers for which felt seal types are available (see **A3-126**).
A felt seal cannot be attached to Ball Spline models using metal retainer.

Model number coding

2	LBR30	UU	CM	+700L	H	K
Model No.	Symbol for clearance in the rotational direction (*2)	Accuracy symbol (*3)	Symbol for spline shaft (*4)			
Number of spline nuts on one shaft (no symbol for one nut) (*1)	Contamination protection accessory symbol (*1)	Overall spline shaft length (*5) (in mm)				

(*1) See **A3-126**. (*2) See **A3-30**. (*3) See **A3-35**. (*4) See **A3-69**. (*5) See **A3-121**.

High Torque Type Ball Spline

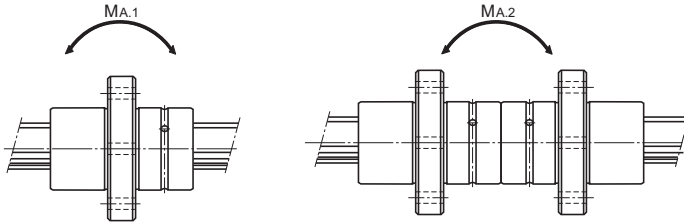

Unit: mm

				Basic torque rating		Basic load rating (radial)		Static permissible moment		Mass	
Mounting hole	F	Lubrication hole	C_T N·m	C_{DT} N·m	C kN	C_0 kN	$M_{A.1}^{**}$ N·m	$M_{A.2}^{**}$ N·m	Spline Nut kg	Spline shaft kg/m	
d_1		d_0									
4.5	7.5	2	30.4	74.5	4.4	8.4	25.4	185	0.14	1	
5.5	12	2	90.2	213	9.4	20.1	103	632	0.33	1.8	
5.5	14	2	176	381	14.9	28.7	171	1060	0.54	2.7	
6.6	16	3	312	657	22.5	41.4	295	1740	0.9	3.8	
9	20.5	3	696	1420	37.1	66.9	586	3540	1.7	6.8	
11	23	4	1290	2500	55.1	94.1	941	5610	2.7	10.6	
11	26	4	1870	3830	66.2	121	1300	8280	3.7	15.6	
14	27	4	3000	6090	90.8	164	2080	11800	6	21.3	
16	32	5	4740	9550	119	213	3180	17300	8.3	32	
18	35	5	6460	14400	137	271	4410	25400	14.2	45	

Note) $M_{A.1}$ indicates the permissible moment value in the axial direction when a single spline nut is used, as shown in the figure above.

$M_{A.2}$ indicates the permissible moment value in the axial direction when two spline nuts in close contact with each other are used, as shown in the figure above.

For details on the maximum lengths of ball spline shafts by accuracy, please see **A3-121**.

Model LBH

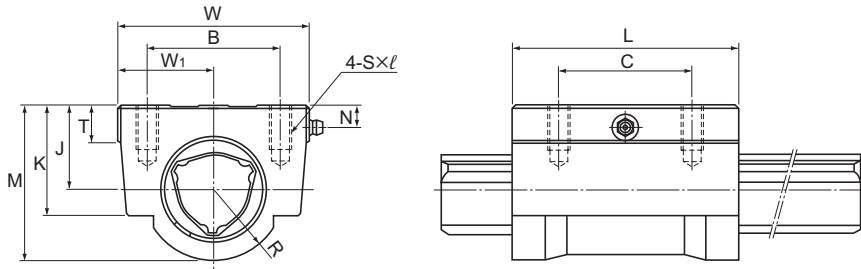

Model No.	Spline nut dimensions									
	Height M	Width W	Length L	B	C	S × l	J ±0.15	W ₁ ±0.15	T	K
○ LBH 15	29	34	43	26	26	M4 × 10	15	17	6	20
○● LBH 20	38	48	62	35	35	M6 × 12	20	24	7	26
○● LBH 25	47	60	73	40	40	M8 × 16	25	30	8	33
○● LBH 30	57	70	83	50	50	M8 × 16	30	35	10	39
○● LBH 40	70	86	102	60	60	M10 × 20	38	43	15	50
○● LBH 50	88	100	115	75	75	M12 × 25	48	50	18	63

Note) ○: indicates model numbers for which high temperature types are available (with metal retainer; service temperature: up to 100°C).

(Example) LBH30 A CM+600L H

└ High temperature symbol

●: indicates model numbers for which felt seal types are available (see **A3-126**).
A felt seal cannot be attached to Ball Spline models using metal retainer.

Model number coding

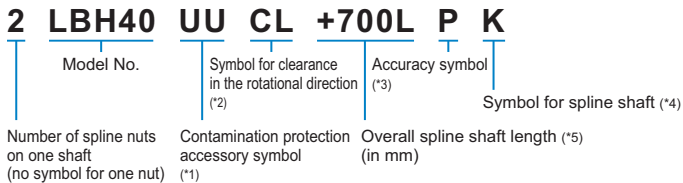

(*1) See **A3-126**. (*2) See **A3-30**. (*3) See **A3-35**. (*4) See **A3-69**. (*5) See **A3-121**.

High Torque Type Ball Spline

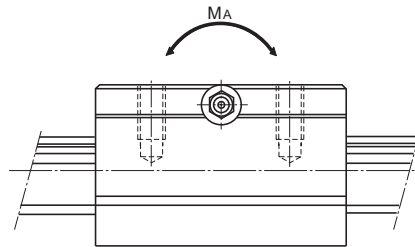

Ball Spline

Unit: mm

				Basic torque rating		Basic load rating (radial)		Static permissible moment	Mass	
R	N	Grease nipple	C_T N·m	C_{OT} N·m	C kN	C_0 kN	M_A^{**} N·m		Spline Nut kg	Spline shaft kg/m
14	5	φ4 drive Nipple	30.4	74.5	4.4	8.4	25.4	0.23	1	
18	7	A-M6F	90.2	213	9.4	20.1	103	0.58	1.8	
22	6	A-M6F	176	381	14.9	28.7	171	1.1	2.7	
26	8	A-M6F	312	657	22.5	41.4	295	1.73	3.8	
32	10	A-M6F	696	1420	37.1	66.9	586	3.18	6.8	
40	13.5	A-PT1/8	1290	2500	55.1	94.1	941	5.1	10.6	

Note) M_A^{**} indicates the permissible moment value in the axial direction when a single spline nut is used, as shown in the figure above.

For details on the maximum lengths of ball spline shafts by accuracy, please see **A3-121**.

Model LBS with Recommended Shaft End Shape

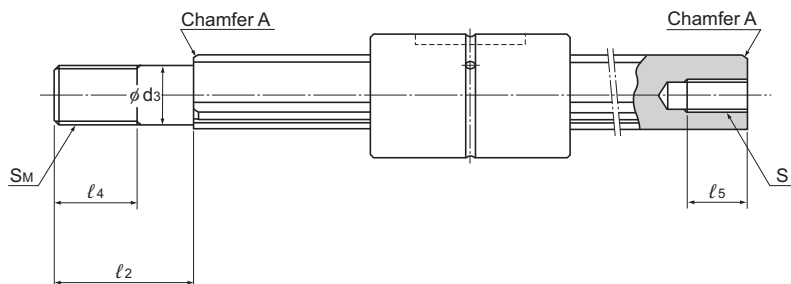

Unit: mm

Model No.	d_3	Tolerance	l_2	S_M	l_4	$S \times l_5$
LBS 15	10	$\begin{matrix} 0 \\ -0.015 \end{matrix}$	23	M10×1.25	14	M6×10
LBS 20	14	$\begin{matrix} 0 \\ -0.018 \end{matrix}$	30	M14×1.5	18	M8×15
LBS 25	18		42	M18×1.5	25	M10×18
LBS 30	20	$\begin{matrix} 0 \\ -0.021 \end{matrix}$	46	M20×1.5	27	M12×20
LBS 40	30		70	M30×2	40	M18×30
LBS 50	36	$\begin{matrix} 0 \\ -0.025 \end{matrix}$	80	M36×3	46	M20×35

Note) For details of chamfer A, see **A3-70**.

Spline Shaft

Spline shafts are divided in shape into precision solid spline shaft, special spline shaft and hollow spline shaft (type K), as described on **A3-57**.

Since production of a spline shaft with a specific shape is performed at your request, provide a drawing of the desired shaft shape when asking an estimate or placing an order.

[Sectional Shape of the Spline Shaft]

Table2 shows the sectional shape of a spline shaft. If the spline shaft ends need to be cylindrical, the minor diameter (ϕd) value should not be exceeded if possible.

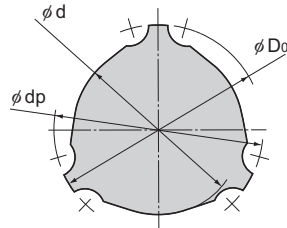

Table2 Sectional Shape of the Spline Shaft

Unit: mm

Nominal shaft diameter	15	20	25	30	40	50	60	70	85	100	120	150
Minor diameter ϕd	11.7	15.3	19.5	22.5	31	39	46.5	54.5	67	81	101	130
Major diameter ϕD_0	14.5	19.7	24.5	29.6	39.8	49.5	60	70	84	99	117	147
Ball center-to-center diameter ϕdp	15	20	25	30	40	50	60	70	85	100	120	150
Mass (kg/m)	1	1.8	2.7	3.8	6.8	10.6	15.6	21.3	32	45	69.5	116.6

*The minor diameter ϕd must be a value at which no groove is left after machining.

[Hole Shape of the Standard Hollow Type Spline Shaft]

Table3 shows the hole shape of the standard hollow type spline shaft. Use this table when a requirement such as piping, wiring, air-vent or weight reduction needs to be met.

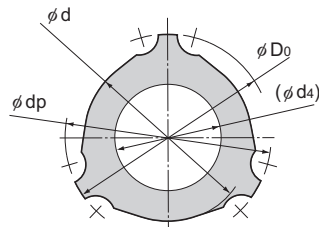

Type K

Table3 Sectional Shape of the Standard Hollow Type Spline Shaft

Unit: mm

Nominal shaft diameter	20	25	30	40	50	60	70	85	100	120	150
Minor diameter ϕd	15.3	19.5	22.5	31	39	46.5	54.5	67	81	101	130
Major diameter ϕD_0	19.7	24.5	29.6	39.8	49.5	60	70	84	99	117	147
Ball center-to-center diameter ϕdp	20	25	30	40	50	60	70	85	100	120	150
Hole diameter (ϕd_4)	6	8	12	18	24	30	35	45	56	60	80
Mass (kg/m)	1.6	2.3	2.9	4.9	7	10	13.7	19.5	25.7	47.3	77.1

*The minor diameter ϕd must be a value at which no groove is left after machining.

[Chamfering of the Spline Shaft Ends]

To facilitate the insertion of the spline shaft into a spline nut, the shaft ends are normally chamfered with the dimensions indicated below unless otherwise specified.

● Chamfer A

If the spline shaft ends are stepped, tapped, or drilled as in Fig. 2, they are machined with the Chamfer A dimensions indicated in Table 4.

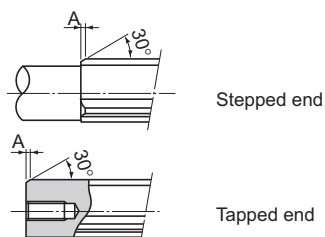

Fig. 2 Chamfer A

● Chamfer B

If either end of the spline shaft is not used, such as for cantilever support, it is machined with the chamfer B dimensions indicated in Table 4.

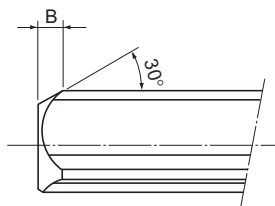

Fig. 3 Chamfer B

Table 4 Chamfer Dimensions of Spline Shaft Ends

Unit: mm

Nominal shaft diameter	15	20	25	30	40	50	60	70	85	100	120	150
Chamfer A	1	1	1.5	2.5	3	3.5	5	6.5	7	7	7.5	8
Chamfer B	3.5	4.5	5.5	7	8.5	10	13	15	16	17	17	18

Note) Spline shafts with nominal diameters 6, 8, and 10 are chamfered to C0.5.

[Length of Imperfect Area of a Special Spline Shaft]

If the middle area or the end of a spline shaft is to be thicker than the minor diameter (ϕd), an imperfect spline area is required to secure a recess for grinding. Table5 shows the relationship between the length of the incomplete section (S) and the flange diameter (ϕdf).

(This table does not apply to overall length of 1,500 mm or greater. Contact THK for details.)

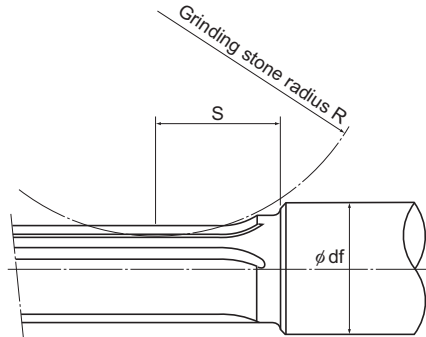

Table5 Length of Imperfect Spline Area: S

Unit: mm

Flange diameter ϕdf	15	20	25	30	35	40	50	60	80	100	120	140	160	180	200
Nominal shaft diameter	15	20	25	30	35	40	50	60	80	100	120	140	160	180	200
15	32	42	49	55	60	—	—	—	—	—	—	—	—	—	—
20	—	35	43	51	57	62	—	—	—	—	—	—	—	—	—
25	—	—	51	64	74	82	97	—	—	—	—	—	—	—	—
30	—	—	—	54	67	76	92	105	—	—	—	—	—	—	—
40	—	—	—	—	—	59	80	95	119	—	—	—	—	—	—
50	—	—	—	—	—	—	63	83	110	131	—	—	—	—	—
60	—	—	—	—	—	—	—	66	100	123	140	—	—	—	—
70	—	—	—	—	—	—	—	—	89	115	134	150	—	—	—
85	—	—	—	—	—	—	—	—	61	98	122	140	—	—	—
100	—	—	—	—	—	—	—	—	—	78	108	130	147	—	—
120	—	—	—	—	—	—	—	—	—	—	81	111	133	150	—
150	—	—	—	—	—	—	—	—	—	—	—	64	101	125	144

*This table does not apply to overall length of 1,500 mm or greater. Contact THK for details.

Accessories

Ball Spline models LBS and LBST are provided with a standard key as indicated in Table6.

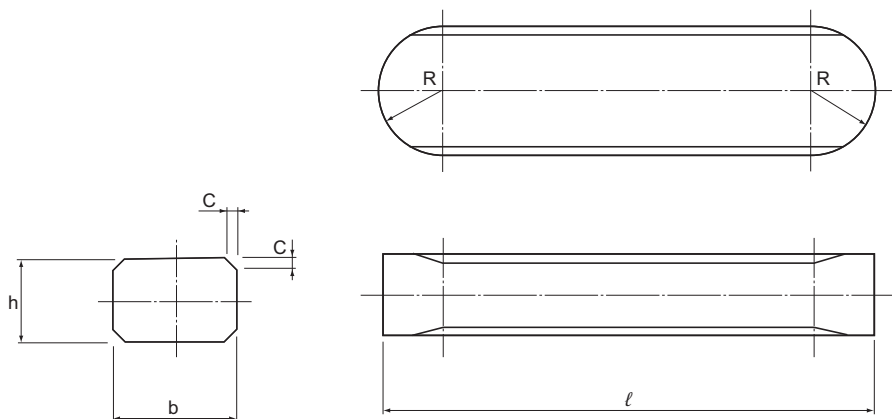

Table6 Standard Keys for Models LBS and LBST

Unit: mm

Nominal shaft diameter	Width b		Height h		Length ℓ		R	C
		Tolerance(p7)		Tolerance(h9)		Tolerance(h12)		
LBS 15	3.5	+0.024 +0.012	3.5	0 -0.030	20	0 -0.210	1.75	0.5
LBS 20 LBST 20	4		4		26		2	
LBS 25 LBST 25	5		5		33	0 -0.250	2.5	
LBS 30 LBST 30	7	+0.030 +0.015	7	0 -0.036	41	0 -0.300	3.5	
LBS 40 LBST 40	10		8		55		5	
LBS 50 LBST 50	15	+0.036 +0.018	10	0 -0.043	60	0 -0.350	7.5	0.8
LBST 60 LBS 70 LBST 70	18		12		68		9	
LBS 85 LBST 85	20		13		80		0 -0.400	14
LBS 100 LBST 100	28	+0.043 +0.022	18	0 -0.400	93	14		
LBST 120	28		18		123	14		
LBST 150	32	+0.051 +0.026	20	0 -0.052	157	0 -0.400	16	2

High Torque Type Ball Spline

Ball Spline

Medium Torque Type Ball Spline

Models LT, LF, LT-X, LF-X, LFK-X, and LFH-X

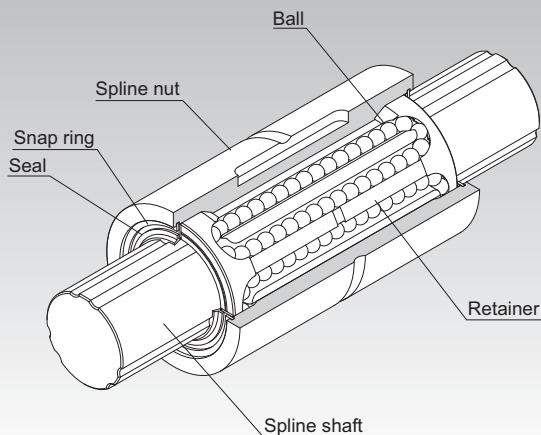

Fig.1 Structure of Medium Torque Type Ball Spline Model LT

Point of Selection **A3-6**

Point of Design **A3-123**

Options **A3-126**

Model No. **A3-128**

Precautions on Use **A3-129**

Accessories for Lubrication **A24-1**

Mounting Procedure and Maintenance **B3-31**

Cross-sectional Characteristics of the Spline Shaft **A3-17**

Equivalent factor **A3-27**

Clearance in the Rotation Direction **A3-30**

Accuracy Standards **A3-35**

Maximum Manufacturing Length by Accuracy **A3-121**

Structure and Features

With the medium torque type Ball Spline, the spline shaft has two to three crests on the circumference, and along both sides of each crest, two rows of balls (four or six rows in total) are arranged to hold the crest so that a reasonable preload is applied.

The rows of balls are held in a special resin retainer incorporated in the spline nut so that they smoothly roll and circulate. With this design, balls will not fall even if the nut is removed from the spline shaft.

[Large Load Capacity]

The raceways are formed into circular-arc grooves approximate to the ball curvature and ensure angular contact. Thus, this model has a large load capacity in the radial and torque directions.

[No Angular Backlash]

Two rows of balls facing one another hold a crest, formed on the circumference of the spline nut, at a contact angle of 20° to provide a preload in an angular-contact structure. This eliminates an angular backlash in the rotational direction and increases the rigidity.

[High Rigidity]

Since the contact angle is large and an appropriate preload is given, high rigidity against torque and moment is achieved.

[Ball Retaining Type]

Use of a retainer prevents the balls from falling even if the spline shaft is pulled out of the spline nut. (except for models LT4 and 5)

Types and Features

[Types of Spline Nuts]

Cylindrical Type Ball Spline Model LT

Specification Table⇒ **A3-80**

The most compact type with a straight cylindrical spline nut. When transmitting a torque, a key is driven into the body.

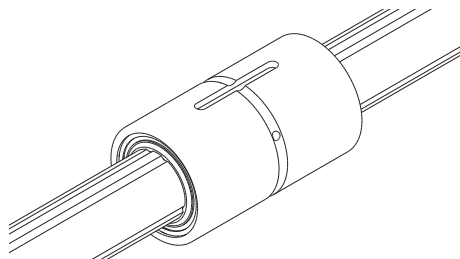

Flanged Type Ball Spline Model LF

Specification Table⇒ **A3-82**

The spline nut can be attached to the housing via the flange, making assembly simple.

It is optimal for locations where the housing may be deformed if a keyway is machined on its surface, and where the housing width is small.

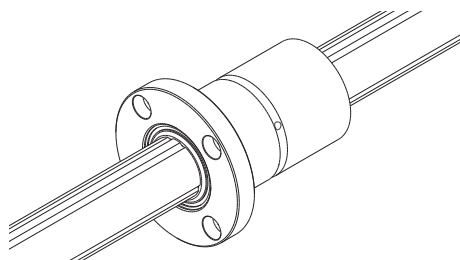

Model LT-X Compact Ball Spline

Specification Table⇒ **A3-84**

The nut is more compact than that of the current Model LT thanks to the new circulating pathways.

The outer diameter of the nut is the same as that of the linear bushing.

The Model LT-XL is suitable for moment loads, torque, and overhung loads that exceed those tolerated by the Model LT-X.

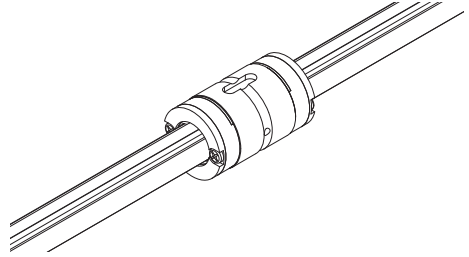

Model LF-X Compact Ball Spline

Specification Table⇒ **A3-86**

The nut is more compact than that of the current Model LF thanks to the new circulating pathways.

The outer diameter of the nut is the same as that of the linear bushing.

The Model LF-XL is suitable for moment loads, torque, and overhung loads that exceed those tolerated by the Model LF-X.

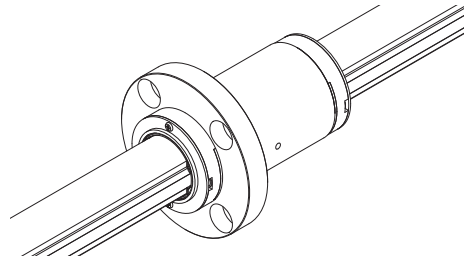

Model LFK-X Compact Ball Spline

Specification Table⇒ **A3-88**

The flange is similar to the Model LF-X, but flattened in four places. Compared to models with round flanges, its core height is lower, and it allows for more compact designs.

The Model LFK-XL is suitable for moment loads or torque and overhang loads that exceed those tolerated by the Model LFK-X.

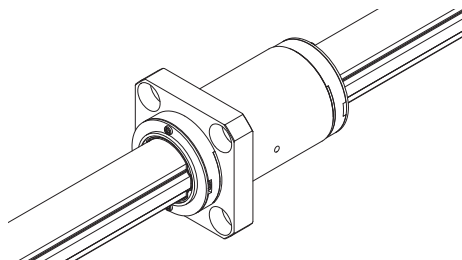

Model LFH-X Compact Ball Spline

Specification Table⇒ **A3-90**

The flange is similar to the Model LF-X, but flattened in two places. Compared to models with square flanges, its core height is lower, and it allows for a lighter overall design.

The Model LFH-XL is suitable for moment loads or torque and overhang loads that exceed those tolerated by the Model LFH-X.

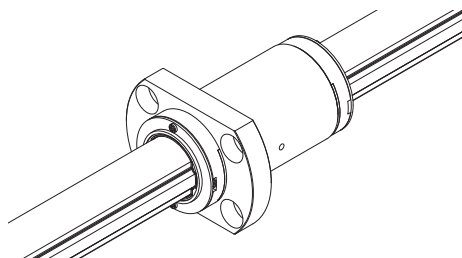

[Types of Spline Shafts]

Precision Solid Spline Shaft (Standard Type)

The raceway of the spline shaft is precision ground. It is used in combination with a spline nut.

**Special Spline Shaft**

THK manufactures a spline shaft with thicker ends or thicker middle area through special processing at your request.

**Hollow Spline Shaft (Type K)**

A drawn, hollow spline shaft is available for requirements such as piping, wiring, air-vent and weight reduction.



Thick

Hollow Spline Shaft (Type N)

A drawn, hollow spline shaft is available for requirements such as piping, wiring, air-vent and weight reduction.



Thin

Housing Inner-diameter Tolerance

When fitting the spline nut to the housing, transition fit is normally recommended. If the accuracy of the Ball Spline does not need to be very high, clearance fitting is also acceptable.

Table1 Housing Inner-diameter Tolerance

Housing Inner-diameter Tolerance	General conditions	H7
	When clearance needs to be small	J6

Model LT

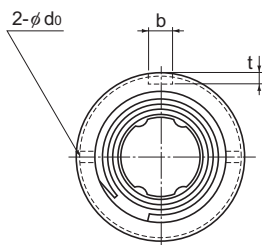

Models LT4 to 13

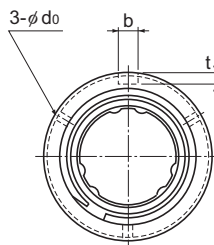

Models LT16 to 100

Model No.	Spline nut dimensions								
	Outer diameter		Length		b H8	Keyway dimensions		r	Lubrication hole d _o
	D	Tolerance	L	Tolerance		t +0.1 0	ℓ _o		
Note) LT 4	10	⁰ -0.009	16	0 -0.2	2	1.2	6	0.5	—
Note) LT 5	12	0 -0.011	20		2.5	1.2	8	0.5	—
LT 6	14		25		2.5	1.2	10.5	0.5	1
LT 8	16		25		2.5	1.2	10.5	0.5	1.5
LT 10	21		33		3	1.5	13	0.5	1.5
LT 13	24	36	3	1.5	15	0.5	1.5		
○ LT 16	31	50	3.5	2	17.5	0.5	2		
○ LT 20	35	63	4	2.5	29	0.5	2		
○ LT 25	42	71	4	2.5	36	0.5	3		
○ LT 30	47	80	4	2.5	42	0.5	3		
○ LT 40	64	100	6	3.5	52	0.5	4		
○ LT 50	80	125	8	4	58	1	4		
○ LT 60	90	140	12	5	67	1	5		
○ LT 80	120	160	16	6	76	2	5		
○ LT 100	150	185	20	7	110	2.5	5		

Note) Models LT4 and 5 do not have a retainer. Do not remove the shaft from the spline nut. (It will cause balls to fall off.)

○: indicates model numbers for which high temperature types are available (with metal retainer, service temperature: up to 100°C).

(Example) LT20 A CL +500L H

High temperature symbol

Model number coding

2 **LT30** **UU** **CL** **+500L** **H** **K**

Model No.

Symbol for clearance
in the rotational direction
(*2)

Accuracy symbol
(*3)

Symbol for spline shaft (*4)

Number of spline nuts
on one shaft
(no symbol for one nut)

Contamination protection
accessory symbol
(*1)

Overall spline shaft length (*5)
(in mm)

(*1) See **A3-126**. (*2) See **A3-30**. (*3) See **A3-35**. (*4) See **A3-93**. (*5) See **A3-121**.

Medium Torque Type Ball Spline

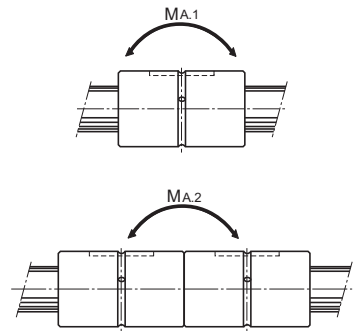
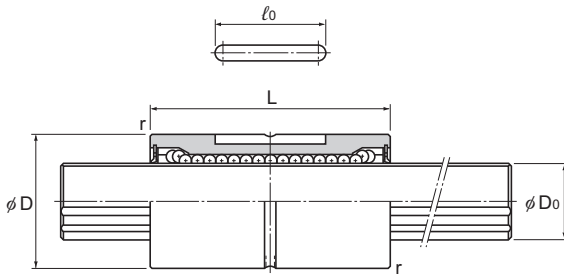

Unit: mm

	Spline shaft diameter D_0 h7	Rows of balls	Basic torque rating		Basic Load Rating		Static permissible moment		Mass	
			C_T N·m	C_{OT} N·m	C kN	C_0 kN	M_{A1}^{**} N·m	M_{A2}^{**} N·m	Spline Nut g	Spline shaft kg/m
	4	4	0.59	0.78	0.44	0.61	0.88	6.4	5.2	0.1
	5	4	0.88	1.37	0.66	0.88	1.5	11.6	9.1	0.15
	6	4	0.98	1.96	1.18	2.16	4.9	36.3	17	0.23
	8	4	1.96	2.94	1.47	2.55	5.9	44.1	18	0.4
	10	4	3.92	7.84	2.84	4.9	15.7	98	50	0.62
	13	4	5.88	10.8	3.53	5.78	19.6	138	55	1.1
	16	6	31.4	34.3	7.06	12.6	67.6	393	165	1.6
	20	6	56.9	55.9	10.2	17.8	118	700	225	2.5
	25	6	105	103	15.2	25.8	210	1140	335	3.9
	30	6	171	148	20.5	34	290	1710	375	5.6
	40	6	419	377	37.8	60.5	687	3760	1000	9.9
	50	6	842	769	60.9	94.5	1340	7350	1950	15.5
	60	6	1220	1040	73.5	111.7	1600	9990	2500	22.3
	80	6	2310	1920	104.9	154.8	2510	16000	4680	39.6
	100	6	3730	3010	136.2	195	3400	24000	9550	61.8

Note) M_{A1} indicates the permissible moment value in the axial direction when a single spline nut is used, as shown in the figure above.

M_{A2} indicates the permissible moment value in the axial direction when two spline nuts in close contact with each other are used, as shown in the figure above.

For details on the maximum lengths of ball spline shafts by accuracy, please see **A3-121**.

Model LF

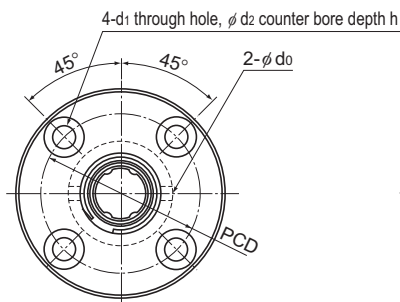

Models LF6 to 13

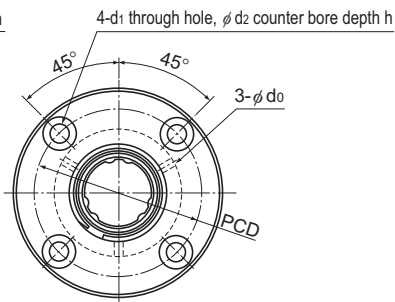

Models LF16 to 50

Model No.	Spline nut dimensions												
	Outer diameter		Length		Flange diameter		H	F	C	r	Lubrication hole		Mounting hole
	D	Tolerance	L	Tolerance	D ₁	Tolerance					d ₀	PCD	
LF 6	14	0	25	0	30	0 -0.2	5	7.5	0.5	0.5	1.5	22	3.4 × 6.5 × 3.3
LF 8	16	-0.011	25		32		5	7.5	0.5	0.5	1.5	24	3.4 × 6.5 × 3.3
LF 10	21	0 -0.013	33	42	6		10.5	0.5	0.5	1.5	32	4.5 × 8 × 4.4	
LF 13	24		36	44	7		11	0.5	0.5	1.5	33	4.5 × 8 × 4.4	
○ LF 16	31	0 -0.016	50	51	7		18	0.5	0.5	2	40	4.5 × 8 × 4.4	
○ LF 20	35		63	58	9		22.5	0.5	0.5	2	45	5.5 × 9.5 × 5.4	
○ LF 25	42	71	65	9	26.5		0.5	0.5	3	52	5.5 × 9.5 × 5.4		
○ LF 30	47	80	75	10	30		0.5	0.5	3	60	6.6 × 11 × 6.5		
○ LF 40	64	100	100	14	36		1	0.5	4	82	9 × 14 × 8.6		
○ LF 50	80	-0.019	125	124	16		46.5	1	1	4	102	11 × 17.5 × 11	

Note) ○: indicates model numbers for which high temperature types are available (with metal retainer; service temperature: up to 100°C).

(Example) LF30 A CL+700L H

High temperature symbol

Model number coding

2	LF20	UU	CM	+400L	P	N
Model No.		Symbol for clearance in the rotational direction (*2)		Accuracy symbol (*3)		Symbol for spline shaft (*4)
Number of spline nuts on one shaft (no symbol for one nut) (*1)		Contamination protection accessory symbol (*1)		Overall spline shaft length (in mm) (*5)		

(*1) See **A3-126**. (*2) See **A3-30**. (*3) See **A3-35**. (*4) See **A3-93**. (*5) See **A3-121**.

Medium Torque Type Ball Spline

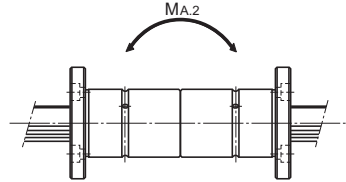
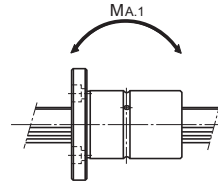
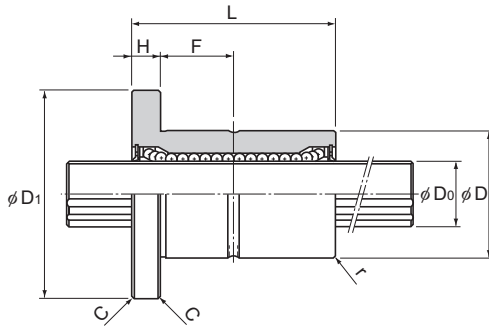

Unit: mm

Ball Spline

	Spline shaft diameter D_0 h7	Rows of balls	Basic torque rating		Basic load rating		Static permissible moment		Mass	
			C_T N·m	C_{OT} N·m	C kN	C_0 kN	M_{A1}^{**} N·m	M_{A2}^{**} N·m	Spline Nut g	Spline shaft kg/m
	6	4	0.98	1.96	1.18	2.16	4.9	36.3	35	0.23
	8	4	1.96	2.94	1.47	2.55	5.9	44.1	37	0.4
	10	4	3.92	7.84	2.84	4.9	15.7	98	90	0.62
	13	4	5.88	10.8	3.53	5.78	19.6	138	110	1.1
	16	6	31.4	34.3	7.06	12.6	67.6	393	230	1.6
	20	6	56.9	55.9	10.2	17.8	118	700	330	2.5
	25	6	105	103	15.2	25.8	210	1140	455	3.9
	30	6	171	148	20.5	34	290	1710	565	5.6
	40	6	419	377	37.8	60.5	687	3760	1460	9.9
	50	6	842	769	60.9	94.5	1340	7350	2760	15.5

Note) M_{A1}^{**} indicates the permissible moment value in the axial direction when a single spline nut is used, as shown in the figure above.

M_{A2}^{**} indicates the permissible moment value in the axial direction when two spline nuts in close contact with each other are used, as shown in the figure above.

For details on the maximum lengths of ball spline shafts by accuracy, please see **A3-121**.

Model LT-X

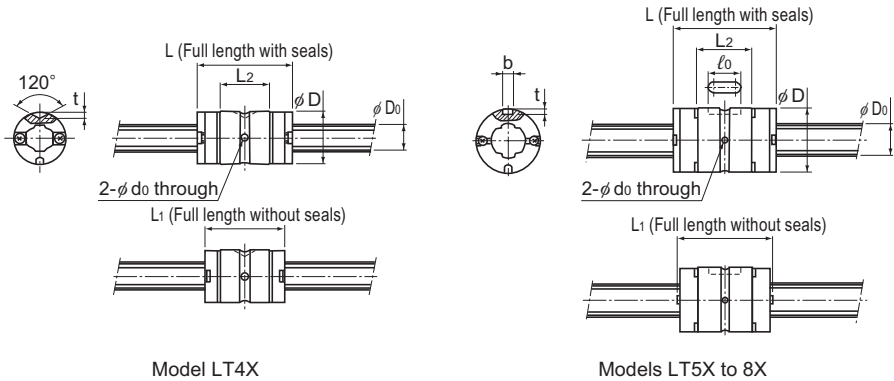

Model LT4X

Models LT5X to 8X

Model No.	Spline shaft diameter		Spline nut dimensions							
	D ₀ h7	Outer diameter		Length			Keyway dimensions			Lubrication hole
		D	Tolerance	L (With seals)	L ₁ (Without seals)	L ₂	b H8	t	l ₀	d ₀
LT 4X	4	8	$\begin{matrix} 0 \\ -0.009 \end{matrix}$	14.4	12	7.5	—	1	—	1
LT 5X LT 5XL	5	10	$\begin{matrix} 0 \\ -0.009 \end{matrix}$	15 26	13.6 24.6	7.3 18.3	2	1.2	4.7	1
LT 6X LT 6XL	6	12	$\begin{matrix} 0 \\ -0.011 \end{matrix}$	19 30	17.6 28.6	10.2 21.2	2	1.2	6	1
LT 8X LT 8XL	8	15	$\begin{matrix} 0 \\ -0.011 \end{matrix}$	25 40	23.8 38.8	14.6 29.6	2.5	1.2	8	1.5
LT 10X	10	19	$\begin{matrix} 0 \\ -0.013 \end{matrix}$	33	30.8	23.9	3	1.5	13	1.5
LT 13X	13	23	$\begin{matrix} 0 \\ -0.013 \end{matrix}$	36	32.4	24	3	1.5	15	1.5
LT 16X	16	28	$\begin{matrix} 0 \\ -0.013 \end{matrix}$	50	46.4	35.5	3.5	2	17.5	2
LT 20X	20	32	$\begin{matrix} 0 \\ -0.016 \end{matrix}$	63	59	47.4	4	2.5	29	2
LT 25X	25	40	$\begin{matrix} 0 \\ -0.016 \end{matrix}$	71	67	52.6	4	2.5	36	3
LT 30X	30	45	$\begin{matrix} 0 \\ -0.016 \end{matrix}$	80	75.6	59.6	4	2.5	42	3

Model number coding

2 LT20X UU CL +700L P K

Model No.

Number of spline nuts
on one shaft
(no symbol for one nut)

Symbol for clearance
in the rotational direction
(⁽²⁾)

Contamination protection
accessory symbol (⁽¹⁾)

Accuracy
symbol (⁽³⁾)

Overall spline shaft length (⁽⁵⁾)
(in mm)

Symbol for spline shaft (⁽⁴⁾)

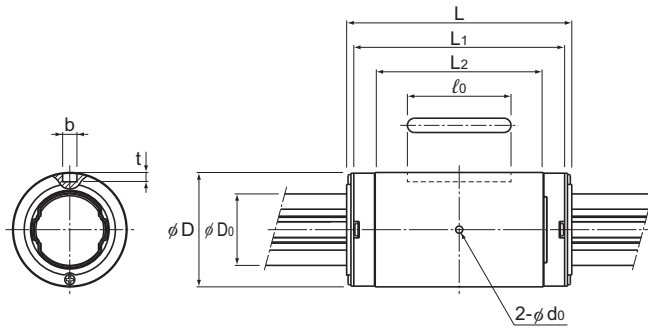

(⁽¹⁾) See **A3-126**. (⁽²⁾) See **A3-30**. (⁽³⁾) See **A3-35**. (⁽⁴⁾) See **A3-93**. (⁽⁵⁾) See **A3-121**.

Medium Torque Type Ball Spline



Models LT10X to 30X

Unit: mm

	Basic torque rating		Basic load rating		Static permissible moment			Mass	
	C_T N·m	C_{OT} N·m	C kN	C_0 kN	M_{A1}  N·m	M_{A2} (With seal)  N·m	M_{A2} (Without seal)  N·m	Spline Nut g	Spline shaft kg/m
	0.49	0.82	0.42	0.7	0.84	6.2	5	2.2	0.1
	0.82 1.59	1.25 3.2	0.56 1.09	0.85 2.19	1.04 6.11	8.2 35.5	6.6 28.4	3.3 8	0.15
	1.73 2.81	2.77 5.54	0.98 1.6	1.58 3.15	2.85 10.6	19 59.8	15.2 47.8	6.6 13.3	0.21
	6 10.1	9.23 19.5	1.39 2.35	2.15 4.53	5.13 21.1	34.3 110.9	27.4 88.7	14.3 24.3	0.38
	9.41	17.3	2.94	5.4	21.5	114	104	30	0.59
	17.1	28.7	4.16	6.96	28.9	164	149	40	1.01
	42.9	68.6	8.4	13.4	77.4	419	381	81	1.52
	66.4	117	10.5	18.6	144	735	669	130	2.41
	125	207	15.9	26.2	230	1183	1077	235	3.71
	196	319	20.8	34	335	1714	1560	295	5.37

Note) The mass of the spline nut does not include the seal.
Please check the spline shaft strength tests (A3-12) before use.

Model LF-X

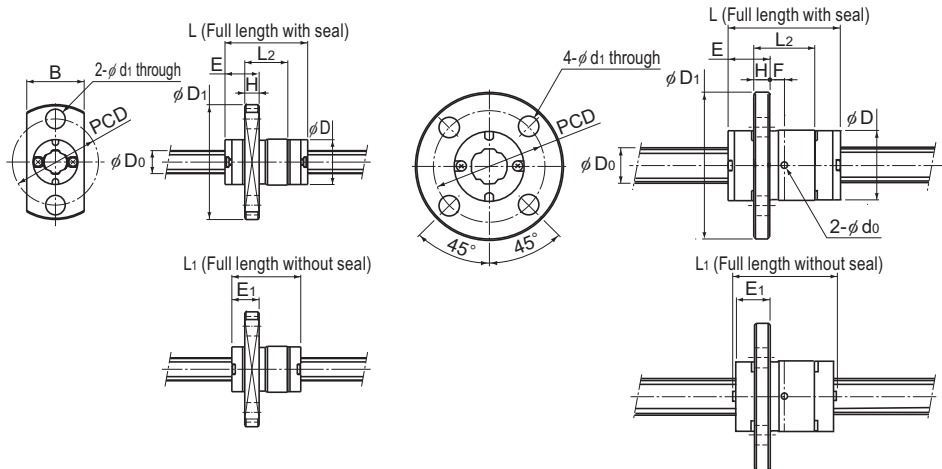

Model LF4X

Models LF5X to 8X

Model No.	Spline shaft diameter		Spline nut dimensions											
	D ₀ h7	Outer diameter		Length			Flange Outer Diameter		H	F	E	E ₁	Lubrication hole d ₀	PCD
		D	Tolerance	L (With seal)	L ₁ (Without seal)	L ₂	D ₁	B						
LF 4X	4	8	⁰ _{-0.009}	14.4	12	7.5	20	10	2.5	—	5.95	4.75	—	15
LF 5X LF 5XL	5	10	⁰ _{-0.009}	15 26	13.6 24.6	7.3 18.3	23	—	2.7	— 6.5	6.55	5.35	— 1	17
LF 6X LF 6XL	6	12	⁰ _{-0.011}	19 30	17.6 28.6	10.2 21.2	25	—	2.7	2.4 7.9	7.1	5.9	1	19
LF 8X LF 8XL	8	15	⁰ _{-0.011}	25 40	23.8 38.8	14.6 29.6	28	—	3.8	3.5 11	9	7.5	1.5	22
LF 10X	10	19	⁰ _{-0.013}	33	30.8	23.9	38	—	6	5.95	10.55	9.45	1.5	28
LF 13X	13	23	⁰ _{-0.013}	36	32.4	24	43	—	6	6	12	10.2	1.5	33
LF 16X	16	28	⁰ _{-0.013}	50	46.4	35.5	48	—	6	11.7	13.3	11.5	2	38
LF 20X	20	32	⁰ _{-0.016}	63	59	47.4	54	—	8	15.7	15.8	13.8	2	43
LF 25X	25	40	⁰ _{-0.016}	71	67	52.6	62	—	8	18.3	17.2	15.2	3	51
LF 30X	30	45	⁰ _{-0.016}	80	75.6	59.6	74	—	10	19.8	20.2	18	3	60

Model number coding

2 LF20X UU CL +700L P K

Model No.

Number of spline nuts
on one shaft
(no symbol for one nut)

Symbol for clearance
in the rotational direction
(*2)

Contamination protection
accessory symbol (*1)

Accuracy
symbol (*3)

Overall spline shaft length (*5)
(in mm)

Symbol for spline shaft (*4)

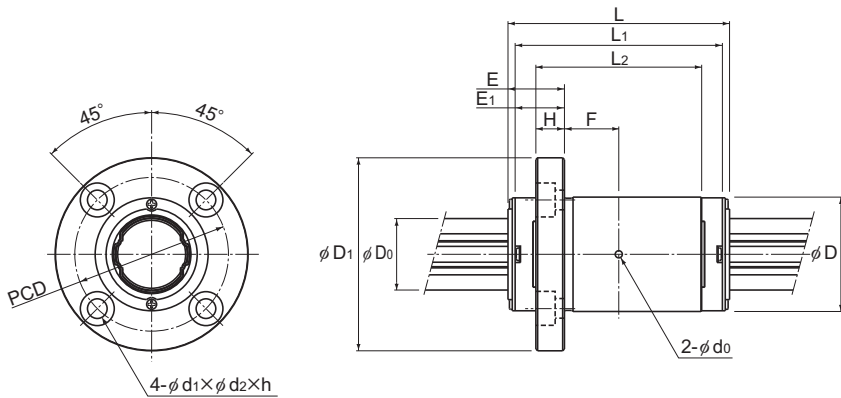

(*1) See **A3-126**. (*2) See **A3-30**. (*3) See **A3-35**. (*4) See **A3-93**. (*5) See **A3-121**.

Medium Torque Type Ball Spline



Models LF10X to 30X

Unit: mm

Mounting hole		Basic torque rating		Basic load rating		Static permissible moment			Mass	
		C_T N·m	C_{OT} N·m	C kN	C_0 kN	M_{A1}  N·m	M_{A2} (With seal)  N·m	M_{A2} (Without seal)  N·m	Spline Nut g	Spline shaft kg/m
$d_1 \times d_2 \times h$	3.4 through	0.49	0.82	0.42	0.7	0.84	6.2	5	4.7	0.1
	3.4 through	0.82 1.59	1.25 3.2	0.56 1.09	0.85 2.19	1.04 6.11	8.2 35.5	6.6 28.4	9.9 14.6	0.15
3.4 through	3.4 through	1.73 2.81	2.77 5.54	0.98 1.6	1.58 3.15	2.85 10.6	19 59.8	15.2 47.8	13.8 20.5	0.21
	3.4 through	6 10.1	9.23 19.5	1.39 2.35	2.15 4.53	5.13 21.1	34.3 110.9	27.4 88.7	26.5 36.5	0.38
4.5×8×4.4	9.41	17.3	2.94	5.4	21.5	114	104	66	0.59	
4.5×8×4.4	17.1	28.7	4.16	6.96	28.9	164	149	82	1.01	
4.5×8×4.4	42.9	68.6	8.4	13.4	77.4	419	381	131	1.52	
5.5×9.5×5.4	66.4	117	10.5	18.6	144	735	669	212	2.41	
5.5×9.5×5.4	125	207	15.9	26.2	230	1183	1077	335	3.71	
6.6×11×6.5	196	319	20.8	34	335	1714	1560	489	5.37	

Note) The mass of the spline nut does not include the seal.
Please check the spline shaft strength tests (A3-12) before use.

Model LFK-X

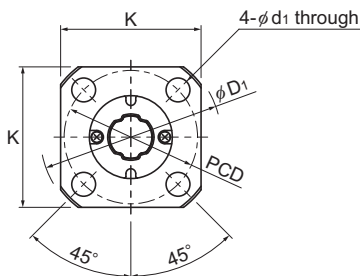

Models LFK5X to 8X

Model No.	Spline shaft diameter		Spline nut dimensions											
	D ₀ h7	Outer diameter		Length			Flange outer diameter		H	F	E	E ₁	Lubrication hole d ₀	PCD
		D	Tolerance	L (With seal)	L ₁ (Without seal)	L ₂	D ₁	K						
LFK 5X LFK 5XL	5	10	0 -0.009	15 26	13.6 24.6	7.3 18.3	23	18	2.7	— 6.5	6.55	5.35	— 1	17
LFK 6X LFK 6XL	6	12	0 -0.011	19 30	17.6 28.6	10.2 21.2	25	20	2.7	2.4 7.9	7.1	5.9	1	19
LFK 8X LFK 8XL	8	15	0 -0.011	25 40	23.8 38.8	14.6 29.6	28	22	3.8	3.5 11	9	7.5	1.5	22
LFK 10X	10	19	0 -0.013	33	30.8	23.9	38	30	6	5.95	10.55	9.45	1.5	28
LFK 13X	13	23	0 -0.013	36	32.4	24	43	34	6	6	12	10.2	1.5	33
LFK 16X	16	28	0 -0.013	50	46.4	35.5	48	37	6	11.7	13.3	11.5	2	38
LFK 20X	20	32	0 -0.016	63	59	47.4	54	42	8	15.7	15.8	13.8	2	43
LFK 25X	25	40	0 -0.016	71	67	52.6	62	50	8	18.3	17.2	15.2	3	51
LFK 30X	30	45	0 -0.016	80	75.6	59.6	74	58	10	19.8	20.2	18	3	60

Model number coding

2 LFK20X UU CL +700L P K

Model No.
Number of spline nuts
on one shaft
(no symbol for one nut)

Symbol for clearance
in the rotational direction
(²)
Contamination protection
accessory symbol (¹)

Accuracy
symbol (³)
Overall spline shaft length (⁵)
(in mm)

Symbol for spline shaft (⁴)

(*1) See **A3-126**. (*2) See **A3-30**. (*3) See **A3-35**. (*4) See **A3-93**. (*5) See **A3-121**.

Medium Torque Type Ball Spline

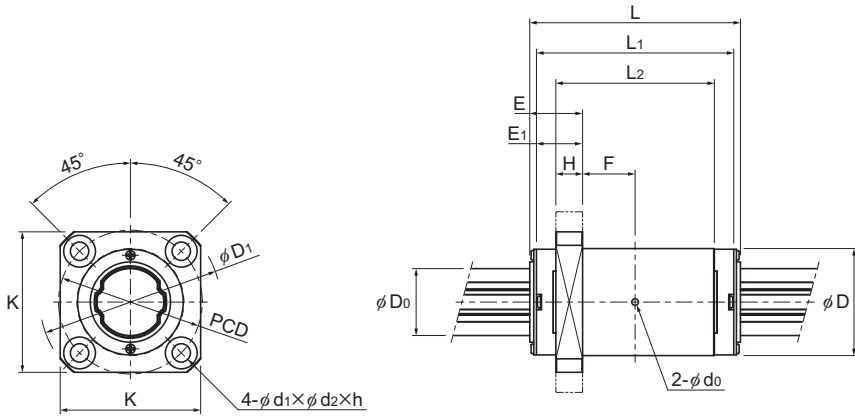

Models LFK10X to 30X

Unit: mm

Mounting hole $d_1 \times d_2 \times h$		Basic torque rating		Basic load rating		Static permissible moment			Mass	
		C_T N·m	C_{OT} N·m	C kN	C_0 kN	M_{A1} N·m	M_{A2} (With seal) N·m	M_{A2} (Without seal) N·m	Spline Nut g	Spline shaft kg/m
3.4 through		0.82 1.59	1.25 3.2	0.56 1.09	0.85 2.19	1.04 6.11	8.2 35.5	6.6 28.4	7.9 12.6	0.15
3.4 through		1.73 2.81	2.77 5.54	0.98 1.6	1.58 3.15	2.85 10.6	19 59.8	15.2 47.8	11.6 18.3	0.21
3.4 through		6 10.1	9.23 19.5	1.39 2.35	2.15 4.53	5.13 21.1	34.3 110.9	27.4 88.7	22.3 32.3	0.38
4.5×8×4.4		9.41	17.3	2.94	5.4	21.5	114	104	54	0.59
4.5×8×4.4		17.1	28.7	4.16	6.96	28.9	164	149	67	1.01
4.5×8×4.4		42.9	68.6	8.4	13.4	77.4	419	381	110	1.52
5.5×9.5×5.4		66.4	117	10.5	18.6	144	735	669	177	2.41
5.5×9.5×5.4		125	207	15.9	26.2	230	1183	1077	298	3.71
6.6×11×6.5		196	319	20.8	34	335	1714	1560	411	5.37

Note) The mass of the spline nut does not include the seal.
Please check the spline shaft strength tests (A3-12) before use.

Model LFH-X

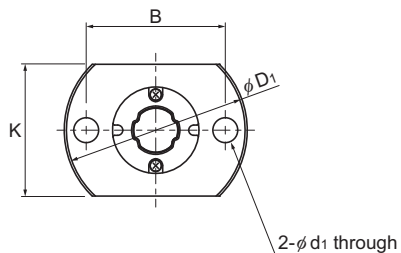

Models LFH5X to 13X

Model No.	Spline shaft diameter		Spline nut dimensions												
	D ₀ h7	Outer diameter		Length			Flange outer diameter		B	C	H	F	E	E ₁	Lubrication hole d ₀
		D	Tolerance	L (With seal)	L ₁ (Without seal)	L ₂	D ₁	K							
LFH 5X LFH 5XL	5	10	⁰ -0.009	15 26	13.6 24.6	7.3 18.3	23	16	17	—	2.7	[—] 6.5	6.55	5.35	[—] 1
LFH 6X LFH 6XL	6	12	⁰ -0.011	19 30	17.6 28.6	10.2 21.2	25	18	19	—	2.7	^{2.4} 7.9	7.1	5.9	1
LFH 8X LFH 8XL	8	15	⁰ -0.011	25 40	23.8 38.8	14.6 29.6	28	21	22	—	3.8	^{3.5} 11	9	7.5	1.5
LFH 10X	10	19	⁰ -0.013	33	30.8	23.9	38	25	29	—	6	5.95	10.55	9.45	1.5
LFH 13X	13	23	⁰ -0.013	36	32.4	24	43	29	33	—	6	6	12	10.2	1.5
LFH 16X	16	28	⁰ -0.013	50	46.4	35.5	48	34	31	22	6	11.7	13.3	11.5	2
LFH 20X	20	32	⁰ -0.016	63	59	47.4	54	38	36	24	8	15.7	15.8	13.8	2
LFH 25X	25	40	⁰ -0.016	71	67	52.6	62	46	40	32	8	18.3	17.2	15.2	3
LFH 30X	30	45	⁰ -0.016	80	75.6	59.6	74	51	49	35	10	19.8	20.2	18	3

Model number coding

2 LFH20X UU CL +700L P K

Model No.

Number of spline nuts
on one shaft
(no symbol for one nut)

Symbol for clearance
in the rotational direction
(⁽²⁾)

Contamination protection
accessory symbol (⁽¹⁾)

Accuracy
symbol (⁽³⁾)

Overall spline shaft length (⁽⁵⁾)
(in mm)

Symbol for spline shaft (⁽⁴⁾)

(*1) See **A3-126**. (*2) See **A3-30**. (*3) See **A3-35**. (*4) See **A3-93**. (*5) See **A3-121**.

Medium Torque Type Ball Spline

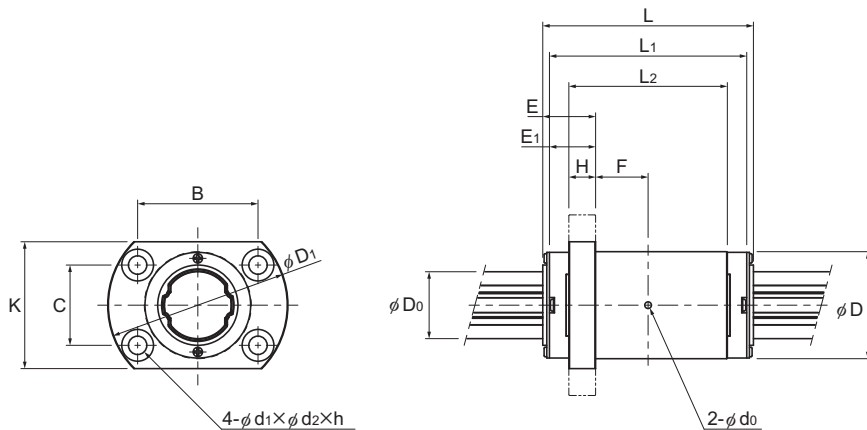

Models LFH16X to 30X

Unit: mm

	Mounting hole $d_1 \times d_2 \times h$	Basic torque rating		Basic load rating		Static permissible moment			Mass	
		C_T N·m	C_{OT} N·m	C kN	C_0 kN	M_{A1} N·m	M_{A2} (With seal) N·m	M_{A2} (Without seal) N·m	Spline Nut g	Spline shaft kg/m
	3.4 through	0.82 1.59	1.25 3.2	0.56 1.09	0.85 2.19	1.04 6.11	8.2 35.5	6.6 28.4	8.6 13.3	0.15
	3.4 through	1.73 2.81	2.77 5.54	0.98 1.6	1.58 3.15	2.85 10.6	19 59.8	15.2 47.8	12.4 19.1	0.21
	3.4 through	6 10.1	9.23 19.5	1.39 2.35	2.15 4.53	5.13 21.1	34.3 110.9	27.4 88.7	24.4 34.4	0.38
	4.5 through	9.41	17.3	2.94	5.4	21.5	114	104	59	0.59
	4.5 through	17.1	28.7	4.16	6.96	28.9	164	149	71	1.01
	4.5 × 8 × 4.4	42.9	68.6	8.4	13.4	77.4	419	381	116	1.52
	5.5 × 9.5 × 5.4	66.4	117	10.5	18.6	144	735	669	186	2.41
	5.5 × 9.5 × 5.4	125	207	15.9	26.2	230	1183	1077	306	3.71
	6.6 × 11 × 6.5	196	319	20.8	34	335	1714	1560	422	5.37

Note) The mass of the spline nut does not include the seal.
Please check the spline shaft strength tests (A3-12) before use.

Model LT with Recommended Shaft End Shape

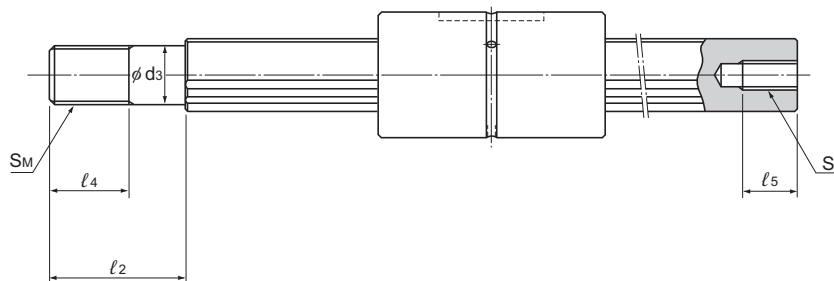

Unit: mm

Model No.	d_3	Tolerance	l_2	S_M	l_4	$S \times l_5$
LT 6	5	0	12	M5×0.8	7	M2.5×4
LT 8	6	-0.012	14	M6×1	8	M3×5
LT 10	8	0	18	M8×1	11	M4×6
LT 13	10	-0.015	23	M10×1.25	14	M5×8
LT 16	14	0	30	M14×1.5	18	M6×10
LT 20	16	-0.018	38	M16×1.5	22	M8×15
LT 25	22	0	50	M22×1.5	28	M10×18
LT 30	27	-0.021	60	M27×2	34	M14×25
LT 40	36	0	80	M36×3	45	M18×30
LT 50	45	-0.025	100	M45×4.5	58	M22×40

Spline Shaft

Spline shafts are divided in shape into precision solid spline shafts, special spline shafts, and hollow spline shafts (types K and N), as described on **A3-79**.

Since production of a spline shaft with a specific shape is performed at your request, provide a drawing of the desired shaft shape when requesting an estimate or placing an order.

[Sectional Shape of the Spline Shaft]

Table2 shows the sectional shape of a spline shaft. If the spline shaft ends need to be cylindrical, the minor diameter (ϕd) value should not be exceeded if possible.

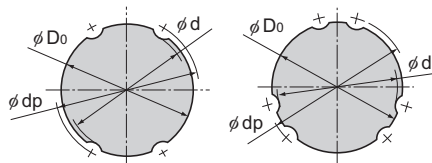

Model LT13 or smaller Model LT16 or greater

Table2 Cross-Sectional Shape of the Spline Shaft for Models LT and LF

Unit: mm

Nominal shaft diameter	4	5	6	8	10	13	16	20	25	30	40	50	60	80	100
Minor diameter ϕd	3.5	4.5	5	7	8.5	11.5	14.5	18.5	23	28	37.5	46.5	56.5	75.5	95
Major diameter ϕD_o h7	4	5	6	8	10	13	16	20	25	30	40	50	60	80	100
Ball center-to-center diameter ϕdp	4.6	5.7	7	9.3	11.5	14.8	17.8	22.1	27.6	33.2	44.2	55.2	66.3	87.9	109.5
Mass(kg/m)	0.1	0.15	0.23	0.4	0.62	1.1	1.6	2.5	3.9	5.6	9.9	15.5	22.3	39.6	61.8

*The minor diameter ϕd must be a value at which no groove is left after machining.

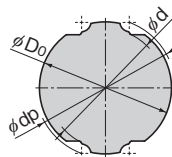

Table3 Cross-Sectional Shape of the Spline Shaft for Models LT-X, LF-X, LFK-X, and LFH-X

Unit: mm

Nominal shaft diameter	4	5	6	8	10	13	16	20	25	30
Minor diameter ϕd	3.6	4.5	5.4	7	8.6	11.3	13.9	17.9	22.4	27
Major diameter ϕD_o	4	5	6	8	10	13	16	20	25	30
Ball center-to-center diameter ϕdp	4.4	5.5	6.6	8.6	10.7	13.8	17.1	21.1	26.4	31.6
Mass (g/m)	100	150	210	380	590	1010	1520	2410	3710	5370

[Hole Shape of the Standard Hollow Type Spline Shaft]

Table4 shows the hole shape of the standard hollow type spline shaft (types K and N).

Use this table when a requirement such as piping, wiring, air-vent or weight reduction needs to be met.

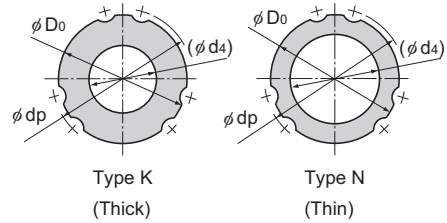
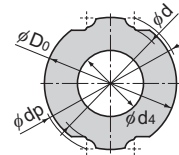

Table4 Cross-Sectional Shape of the Standard Hollow Spline Shaft for Models LT and LF Unit: mm

Nominal shaft diameter	6	8	10	13	16	20	25	30	40	50	60	80	100	
Major diameter ϕD_0 h7	6	8	10	13	16	20	25	30	40	50	60	80	100	
Ball center-to-center diameter ϕdp	7	9.3	11.5	14.8	17.8	22.1	27.6	33.2	44.2	55.2	66.3	87.9	109.5	
Type K	Hole diameter (ϕd_4)	2.5	3	4	5	7	10	12	16	22	25	32	52.5	67.5
	Mass(kg/m)	0.2	0.35	0.52	0.95	1.3	1.8	3	4	6.9	11.6	16	22.6	33.7
Type N	Hole diameter (ϕd_4)	—	—	—	—	11	14	18	21	29	36	—	—	—
	Mass(kg/m)	—	—	—	—	0.8	1.3	1.9	2.8	4.7	7.4	—	—	—

Note) The standard hollow type Spline Shaft is divided into types K and N. Indicate "K" or "N" at the end of the model number to distinguish between them when placing an order.



Type K (Thick)

Table5 Cross-Sectional Shape of the Hollow Spline Shaft for Models LT-X, LF-X, LFK-X, and LFH-X (K Type) Unit: mm

Nominal shaft diameter	4	5	6	8	10	13	16	20	25	30
Minor diameter ϕd	—	—	—	—	8.6	11.3	13.9	17.9	22.4	27
Major diameter ϕD_0	—	—	—	—	10	13	16	20	25	30
Ball center-to-center diameter ϕdp	—	—	—	—	10.7	13.8	17.1	21.1	26.4	31.6
Hole diameter ϕd_4	—	—	—	—	4	5	7	10	12	16
Mass (g/m)	—	—	—	—	490	850	1220	1790	2820	3780

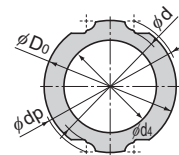

Type N (Thin)

Table6 Cross-Sectional Shape of the Hollow Spline Shaft for Models LT-X, LF-X, LFK-X, and LFH-X (N Type) Unit: mm

Nominal shaft diameter	4	5	6	8	10	13	16	20	25	30
Minor diameter ϕd	—	—	—	—	—	—	13.9	17.9	22.4	27
Major diameter ϕD_0	—	—	—	—	—	—	16	20	25	30
Ball center-to-center diameter ϕdp	—	—	—	—	—	—	17.1	21.1	26.4	31.6
Hole diameter ϕd_4	—	—	—	—	—	—	11	14	18	21
Mass (g/m)	—	—	—	—	—	—	770	1190	1700	2630

[Chamfering of the Spline Shaft Ends]

To facilitate the insertion of the spline shaft into a spline nut, the shaft ends are normally chamfered with the dimensions indicated below unless otherwise specified.

The ends are chamfered whether they are used, such as with stepped, tapped, or drilled ends, or not used, such as with cantilevered supports.

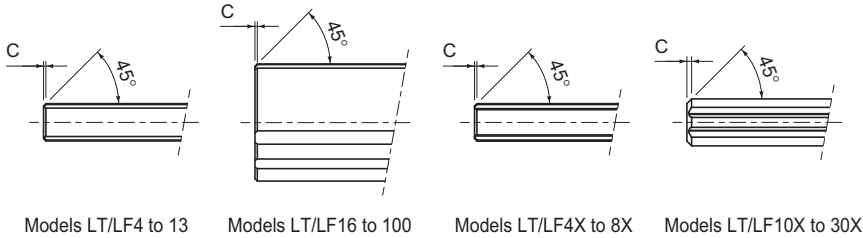

Table 7 Chamfer Dimensions of Model LT and Model LF Spline Shaft Ends

Unit: mm

Nominal shaft diameter	4	5	6	8	10	13	16	20	25	30	32	40	50	60	80	100
Chamfer C	0.3	0.3	0.5	0.5	0.5	0.5	0.5	0.5	0.5	0.5	0.5	1	1	2	2	2

Table 8 Chamfer Dimensions of Models LT-X, LF-X, LFK-X, and LFH-X Spline Shaft Ends

Unit: mm

Nominal shaft diameter	4	5	6	8	10	13	16	20	25	30
Chamfer C	0.3	0.3	0.5	0.5	1.5	1.5	1.5	1.5	2	2

[Length of the Incomplete Area of a Special Spline Shaft]

If the middle area or the end of a spline shaft is to be thicker than the minor diameter (ϕd), an imperfect spline area is required to secure a recess for grinding. Table 9 shows the relationship between the length of the incomplete section (S) and the flange diameter (ϕdf).

(This table does not apply to overall length of 1,500 mm or greater. Contact THK for details.)

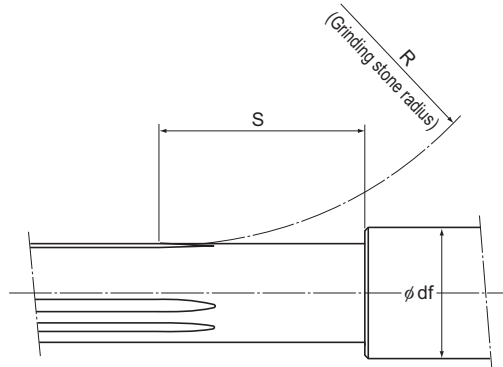

Table9 Length of Imperfect Spline Area: S Miniature type

Unit: mm

Flange diameter ϕ df	4	5	6	8	10
Nominal shaft diameter					
4	23	25	27	31	—
5	—	24	26	29	33

Standard Type

Unit: mm

Flange diameter ϕ df	Standard Type															
	6	8	10	13	16	20	25	30	40	50	60	80	100	120	140	160
Nominal shaft diameter																
6	24	28	31	39	—	—	—	—	—	—	—	—	—	—	—	—
8	—	25	29	35	41	—	—	—	—	—	—	—	—	—	—	—
10	—	—	26	31	38	45	—	—	—	—	—	—	—	—	—	—
13	—	—	—	33	39	46	56	—	—	—	—	—	—	—	—	—
16	—	—	—	—	36	47	58	67	—	—	—	—	—	—	—	—
20	—	—	—	—	—	37	50	60	76	—	—	—	—	—	—	—
25	—	—	—	—	—	—	38	51	72	88	—	—	—	—	—	—
30	—	—	—	—	—	—	—	40	62	80	95	—	—	—	—	—
40	—	—	—	—	—	—	—	—	42	63	81	107	—	—	—	—
50	—	—	—	—	—	—	—	—	—	45	65	96	118	—	—	—
60	—	—	—	—	—	—	—	—	—	—	50	87	114	134	—	—
80	—	—	—	—	—	—	—	—	—	—	—	53	89	115	135	—
100	—	—	—	—	—	—	—	—	—	—	—	—	57	90	116	136

*This table does not apply to overall length of 1,500 mm or greater. Contact THK for details.

Compact Type

Unit: mm

Flange diameter ϕ df	Compact Type													
	4	5	6	8	10	13	16	20	25	30	35	40	50	60
Nominal shaft diameter														
4X	23	25	27	31	—	—	—	—	—	—	—	—	—	—
5X	—	24	26	29	33	—	—	—	—	—	—	—	—	—
6X	—	—	24	28	31	39	—	—	—	—	—	—	—	—
8X	—	—	—	25	29	35	41	—	—	—	—	—	—	—
10X	—	—	—	—	26	40	48	56	—	—	—	—	—	—
13X	—	—	—	—	—	33	41	51	61	—	—	—	—	—
16X	—	—	—	—	—	—	36	47	58	67	—	—	—	—
20X	—	—	—	—	—	—	—	37	50	60	67	76	—	—
25X	—	—	—	—	—	—	—	—	38	51	59	72	88	—
30X	—	—	—	—	—	—	—	—	—	40	50	62	80	95

Accessories

Ball Spline model LT is provided with a standard key as indicated in Table10.

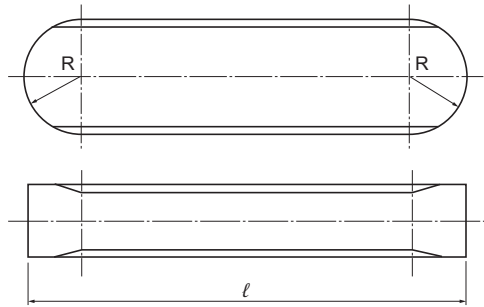
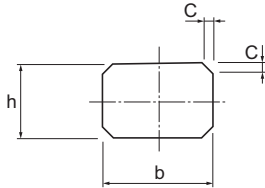

Table10 Standard Key for Model LT

Unit: mm

Nominal shaft diameter	Width b		Height h		Length l		R	C	
		Tolerance(p7)		Tolerance(h9)		Tolerance(h12)			
LT 4	2	+0.016 +0.006	2	0 -0.025	6	0 -0.120	1	0.3	
LT 5	2.5		2.5		8	0 -0.150	1.25	0.5	
LT 5X	2		2		4.7	0	1	0.2	
LT 5XL	2		2		4.7	-0.120	1		
LT 6	2.5		2.5		10.5	0 -0.180	1.25	0.5	
LT 6X	2		2		6	0	1	0.3	
LT 6XL	2		2		6	-0.120	1		
LT 8	2.5		2.5		10.5	0 -0.180	1.25	0.5	
LT 8X	2.5		2.5		8	0	1.25		
LT 8XL	2.5		2.5		8	-0.150	1.25		
LT 10	3		3		13	0 -0.180	1.5	1.5	
LT 10X	3		3		13				
LT 13	3		3		15		1.5	1.5	
LT 13X	3		3		15		-0.180		
LT 16	3.5		3.5		17.5	0 -0.210	1.75	0.5	
LT 16X	3.5		3.5		17.5		1.75		
LT 20	4		4		29		2		
LT 20X	4		4		29		-0.210	2	
LT 25	4		4		36		0 -0.250	2	2
LT 25X	4		4		36				
LT 30	4	4	42						
LT 30X	4	4	42						
LT 40	6	6	52	0 -0.300	3		0.8		
LT 50	8	+0.030 +0.015	7		4				
LT 60	12	+0.036	8		6				
LT 80	16	+0.018	10		8				
LT 100	20	+0.043 +0.022	13	0 -0.043	110	0 -0.350	10		

Rotary Ball Spline

Geared Type Models LBG and LBGT

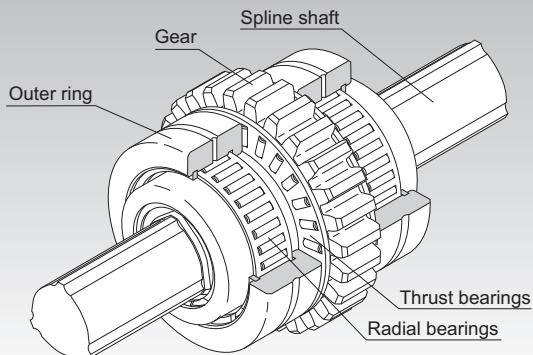

Fig.1 Structure of Rotary Ball Spline Model LBG

Point of Selection	A3-6
Point of Design	A3-123
Options	A3-126
Model No.	A3-128
Precautions on Use	A3-129
Accessories for Lubrication	A24-1
Mounting Procedure and Maintenance	B3-31
Cross-sectional Characteristics of the Spline Shaft	A3-17
Equivalent factor	A3-27
Clearance in the Rotation Direction	A3-30
Accuracy Standards	A3-35
Maximum Manufacturing Length by Accuracy	A3-121

Structure and Features

With the Rotary Ball Spline, the spline shaft has three crests, and along both sides of each crest, two rows of balls (six rows in total) are arranged to hold the crest so that a reasonable preload is applied.

These models are unit types based on model LBR, but have gear teeth on the flange circumference and radial and thrust bearings on the spline nut, all compactly integrated.

The rows of balls are held in a special resin retainer so that they smoothly roll and circulate. With this design, balls will not fall even if the spline shaft is removed.

[No Angular Backlash]

The spline shaft has three crests positioned equidistantly at 120° and along both sides of each crest, two rows of balls (six rows in total) are arranged so as to hold the crest at a contact angle of 45° and provide a preload. As a result, backlash in the rotational direction is eliminated and the rigidity is increased.

[Compact Design]

The spline nut is compactly integrated with radial and thrust bearings, allowing compact design to be achieved.

[High Rigidity]

Since the contact angle is large and an appropriate preload is given, high rigidity against torque and moment is achieved.

Use of needle bearings in the support unit achieves a rigid nut support strong against a radial load.

[Optimal for Torque Transmission with Spline Nut Drive]

Since the support bearings allow a rigid nut support, these models are optimal for torque transmission with spline nut drive.

Types and Features

[Types of Spline Nuts]

Ball Spline with Gears Model LBG

Specification Table⇒ **A3-102**

These models are unit types based on model LBR, but have gear teeth on the flange circumference and radial and thrust bearings on the spline nut, all compactly integrated. It is optimal for a torque transmission mechanism with spline nut drive.

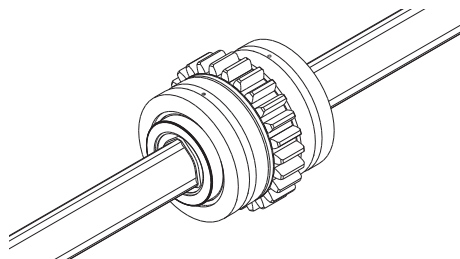

Without a thrust raceway

Ball Spline with Gears Model LBGT

Specification Table⇒ **A3-104**

These models are unit types based on model LBR, but have gear teeth on the flange circumference and radial and thrust bearings on the spline nut, all compactly integrated. It is optimal for a torque transmission mechanism with spline nut drive.

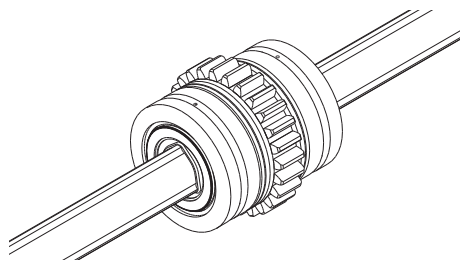

With a thrust raceway

[Types of Spline Shafts]

For details, see **A3-57**.

Housing Inner-diameter Tolerance

Table1 shows housing inner-diameter tolerance for models LBG and LBGT.

Table1 Housing Inner-diameter Tolerance

Housing Inner-diameter Tolerance	General conditions	H7
	When clearance needs to be small	J6

Model LBG

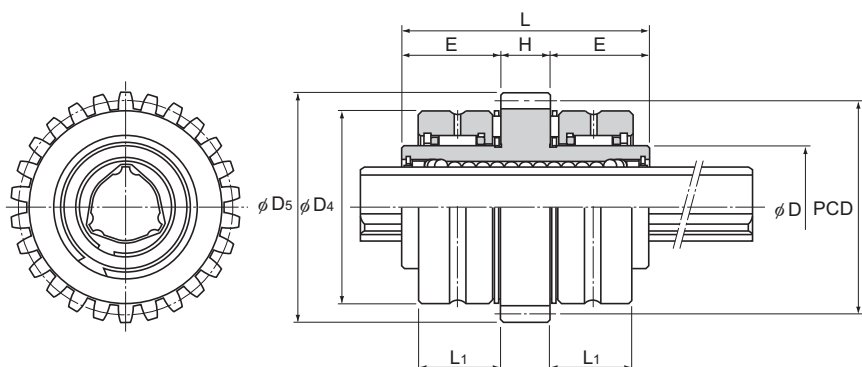

Model No.	Spline nut dimensions									
	Spline nut outer diameter		Length		Outer diameter		Width		H	E
	D	Tolerance	L	Tolerance	D ₄	Tolerance	L ₁	Tolerance		
● LBG 20	30	0 -0.009	60	0 -0.2	47	0 -0.011	20	0 -0.16	12	24
● LBG 25	40	0 -0.011	70		60	0 -0.013	23	0 -0.19	14	28
● LBG 30	45	0 -0.013	80		65	0 -0.015	27	0 -0.25	16	32
● LBG 40	60	0 -0.015	100	0 -0.3	85	0 -0.025	31	0 -0.25	18	41
● LBG 50	75	0 -0.015	112		100	0 -0.025	32		20	46
LBG 60	90	0 -0.015	127		120	0 -0.025	38		22	52.5
● LBG 85	120	0 -0.015	155		150	0 -0.025	40		26	64.5

Note) ●: indicates model numbers for which felt seal types are available (see **A3-126**).

Model number coding

2	LBG50	UU	CM	+700L	H	K
Model No.		Symbol for clearance in the rotational direction (*2)		Accuracy symbol (*3)		Symbol for spline shaft (*4)
Number of spline nuts on one shaft (no symbol for one nut)		Contamination protection accessory symbol (*1)		Overall spline shaft length (*5) (in mm)		

(*1) See **A3-126**. (*2) See **A3-30**. (*3) See **A3-35**. (*4) See **A3-106**. (*5) See **A3-121**.

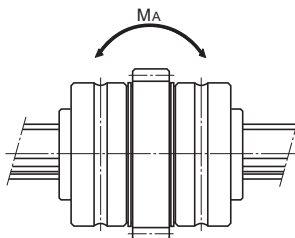

Unit: mm

	Gear specifications*				Basic torque rating		Basic load rating		Static permissible moment	Mass	
	Tip circle diameter D_s	Standard pitch diameter PCD	Module m	Number of teeth z	C_T N·m	C_{OT} N·m	C kN	C_0 kN	M_A^{**} N·m	Spline nut unit kg	Spline shaft kg/m
	56	52	2	26	90.2	213	9.4	20.1	103	0.61	1.8
	70	65	2.5	26	176	381	14.9	28.7	171	1.4	2.7
	75	70	2.5	28	312	657	22.5	41.4	295	2.1	3.8
	96	90	3	30	696	1420	37.1	66.9	586	3	6.8
	111	105	3	35	1290	2500	55.1	94.1	941	4.1	10.6
	133	126	3.5	36	1870	3830	66.2	121	1300	6.3	15.6
	168	160	4	40	4740	9550	119	213	3180	11.8	32

Note) *The gear specifications in the table represent the dimensions with maximum module.

Special gear types such as helical gear and worm gear can also be manufactured at your request.

** M_A indicates the permissible moment value in the axial direction when a single spline nut is used, as shown in the figure above.

For details on the maximum lengths of ball spline shafts by accuracy, please see **A3-121**.

Model LBGT

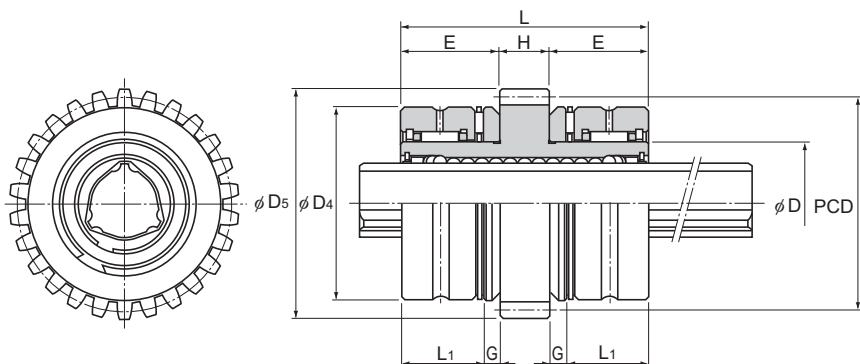

Model No.	Spline nut dimensions										
	Spline nut outer diameter		Length		Outer diameter		Width		Thrust raceway width	H	E
	D	Tolerance	L	Tolerance	D ₄	Tolerance	L ₁	Tolerance			
● LBGT 20	30	⁰ _{-0.009}	60	0 -0.2	47	⁰ _{-0.011}	20	⁰ _{-0.16}	4	12	24
● LBGT 25	40	⁰ _{-0.011}	70		60	⁰ _{-0.013}	23	⁰ _{-0.19}	5	14	28
● LBGT 30	45	⁰ _{-0.011}	80		65	⁰ _{-0.015}	27	⁰ _{-0.25}	5	16	32
● LBGT 40	60	⁰ _{-0.013}	100	0 -0.3	85	⁰ _{-0.025}	31	0 -0.25	8	18	41
● LBGT 50	75	⁰ _{-0.015}	112		100	⁰ _{-0.025}	32		10	20	46
LBGT 60	90	⁰ _{-0.015}	127		120	⁰ _{-0.025}	38		12	22	52.5
● LBGT 85	120	⁰ _{-0.015}	155	150	⁰ _{-0.025}	40	16	26	64.5		

Note) ● indicates model numbers for which felt seal types are available (see **A3-126**).

Model number coding

2 LBGT40 UU CL +700L P K

2	LBGT40	UU	CL	+700L	P	K
Model No.	Symbol for clearance in the rotational direction (⁽²⁾)	Accuracy symbol (⁽³⁾)	Symbol for spline shaft (⁽⁴⁾)			
Number of spline nuts on one shaft (no symbol for one nut) (⁽¹⁾)	Contamination protection accessory symbol (⁽¹⁾)	Overall spline shaft length (⁽⁵⁾) (in mm)				

(*1) See **A3-126**. (*2) See **A3-30**. (*3) See **A3-35**. (*4) See **A3-106**. (*5) See **A3-121**.

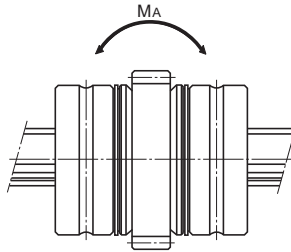

Unit: mm

	Gear specifications*				Basic torque rating		Basic load rating		Static permissible moment	Mass	
	Tip circle diameter D_s	Standard pitch diameter PCD	Module m	Number of teeth z	C_T N·m	C_{OT} N·m	C kN	C_0 kN	M_A^{**} N·m	Spline nut unit kg	Spline shaft kg/m
	56	52	2	26	90.2	213	9.4	20.1	103	0.67	1.8
	70	65	2.5	26	176	381	14.9	28.7	171	1.5	2.7
	75	70	2.5	28	312	657	22.5	41.4	295	2.2	3.8
	96	90	3	30	696	1420	37.1	66.9	586	3.3	6.8
	111	105	3	35	1290	2500	55.1	94.1	941	4.8	10.6
	133	126	3.5	36	1870	3830	66.2	121	1300	7.2	15.6
	168	160	4	40	4740	9550	119	213	3180	13.4	32

Note) *The gear specifications in the table represent the dimensions with maximum module.

Special gear types such as helical gear and worm gear can also be manufactured at your request.

** M_A indicates the permissible moment value in the axial direction when a single spline nut is used, as shown in the figure above.

For details on the maximum lengths of ball spline shafts by accuracy, please see **A3-121**.

Spline Shaft

Spline shafts are divided in shape into precision solid spline shaft, special spline shaft and hollow spline shaft (type K), as described on **A3-57**.

Since production of a spline shaft with a specific shape is performed at your request, provide a drawing of the desired shaft shape when asking an estimate or placing an order.

[Sectional Shape of the Spline Shaft]

Table2 shows the sectional shape of a spline shaft. If the spline shaft ends need to be cylindrical, the minor diameter (ϕd) value should not be exceeded if possible.

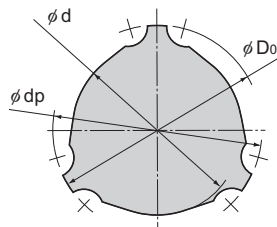

Table2 Sectional Shape of the Spline Shaft

Unit: mm

Nominal shaft diameter	20	25	30	40	50	60	85
Minor diameter ϕd	15.3	19.5	22.5	31	39	46.5	67
Major diameter ϕD_0	19.7	24.5	29.6	39.8	49.5	60	84
Ball center-to-center diameter ϕdp	20	25	30	40	50	60	85
Mass (kg/m)	1.8	2.7	3.8	6.8	10.6	15.6	32

*The minor diameter ϕd must be a value at which no groove is left after machining.

[Hole Shape of the Standard Hollow Type Spline Shaft]

Table3 shows the hole shape of the standard hollow type spline shaft (type K) for models LBG and LBG7.

Use this table when a requirement such as piping, wiring, air-vent or weight reduction needs to be met.

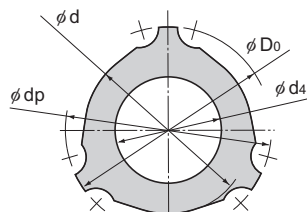

Type K

Table3 Sectional Shape of the Standard Hollow Type Spline Shaft

Unit: mm

Nominal shaft diameter	20	25	30	40	50	60	85
Minor diameter ϕd	15.3	19.5	22.5	31	39	46.5	67
Major diameter ϕD_0	19.7	24.5	29.6	39.8	49.5	60	84
Ball center-to-center diameter ϕdp	20	25	30	40	50	60	85
Hole diameter ϕd_1	6	8	12	18	24	30	45
Mass (kg/m)	1.6	2.3	2.9	4.9	7	10	19.5

*The minor diameter ϕd must be a value at which no groove is left after machining.

[Chamfering of the Spline Shaft Ends]

To facilitate the insertion of the spline shaft into a spline nut, the shaft ends are normally chamfered with the dimensions indicated below unless otherwise specified.

● **Chamfer A**

If the spline shaft ends are stepped, tapped, or drilled as in Fig. 2, they are machined with the Chamfer A dimensions indicated in Table 4.

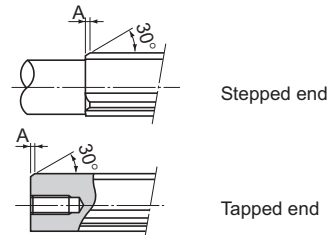

Fig. 2 Chamfer A

● **Chamfer B**

If either end of the spline shaft is not used, such as for cantilever support, it is machined with the Chamfer B dimensions indicated in Table 4.

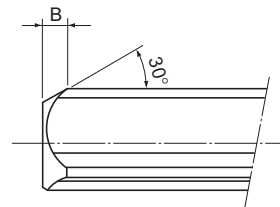

Fig. 3 Chamfer B

Table 4 Chamfer Dimensions of Spline Shaft Ends

Unit: mm

Nominal shaft diameter	20	25	30	40	50	60	85
Chamfer A	1	1.5	2.5	3	3.5	5	7
Chamfer B	4.5	5.5	7	8.5	10	13	16

Note) Spline shafts with nominal diameters 6, 8, and 10 are chamfered to C0.5.

[Length of Imperfect Area of a Special Spline Shaft]

If the middle area or the end of a spline shaft is to be thicker than the minor diameter (ϕd), an imperfect spline area is required to secure a recess for grinding. Table5 shows the relationship between the length of the incomplete section (S) and the flange diameter (ϕdf).

(This table does not apply to overall length of 1,500 mm or greater. Contact THK for details.)

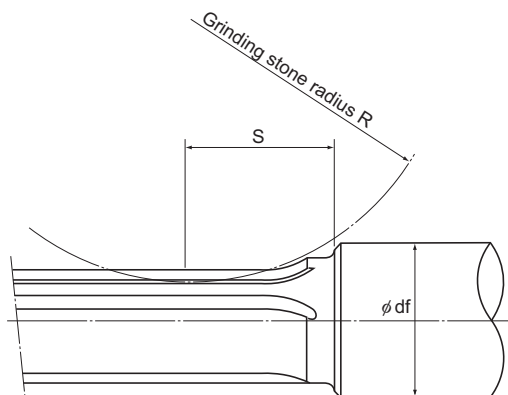

Table5 Length of Imperfect Spline Area: S

Unit: mm

Flange diameter ϕdf	20	25	30	35	40	50	60	80	100	120	140
Nominal shaft diameter	20	25	30	35	40	50	60	80	100	120	140
	35	43	51	57	62	—	—	—	—	—	—
	—	51	64	74	82	97	—	—	—	—	—
	—	—	54	67	76	92	105	—	—	—	—
	—	—	—	—	59	80	95	119	—	—	—
	—	—	—	—	—	63	83	110	131	—	—
	—	—	—	—	—	—	66	100	123	140	—
	—	—	—	—	—	—	—	61	98	122	140

Rotary Ball Spline

Support Bearing Type Models LTR and LTR-A

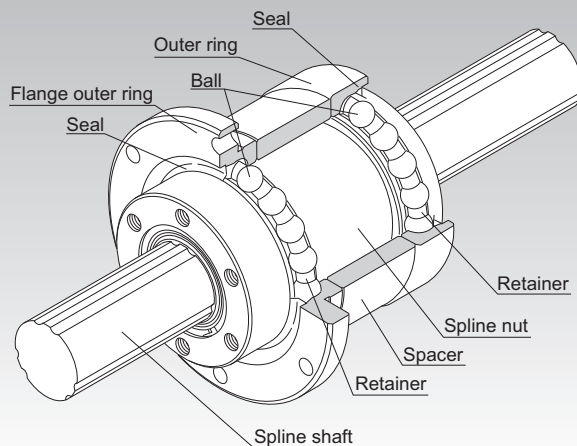

Fig.1 Structure of Rotary Ball Spline Model LTR

Point of Selection	A3-6
Point of Design	A3-123
Options	A3-126
Model No.	A3-128
Precautions on Use	A3-129
Accessories for Lubrication	A24-1
Mounting Procedure and Maintenance	B3-31
Cross-sectional Characteristics of the Spline Shaft	A3-17
Equivalent factor	A3-27
Clearance in the Rotation Direction	A3-30
Accuracy Standards	A3-35
Maximum Manufacturing Length by Accuracy	A3-121

Structure and Features

With the Rotary Ball Spline model LTR, the spline shaft has three crests on the circumference, and along both sides of each crest, two rows of balls (six rows in total) are arranged to hold the crest so that a reasonable preload is applied.

Angular-contact ball raceways are machined on the outer surface of the spline nut to constitute support bearings, allowing the whole body to be compactly and lightly designed.

The rows of balls are held in a special resin retainer so that they smoothly roll and circulate. With this design, balls will not fall even if the spline shaft is removed.

In addition, a dedicated seal for preventing foreign material from entering the support bearings is available.

[No Angular Backlash]

Two rows of balls facing one another hold a crest, formed on the circumference of the spline nut, at a contact angle of 20° to provide a preload in an angular-contact structure. This eliminates an angular backlash in the rotational direction and increases the rigidity.

[Compact Design]

The spline nut is integrated with the support bearings, allowing highly accurate, compact design to be achieved.

[Easy Installation]

This ball spline can easily be installed by simply securing it to the housing using bolts.

[High Rigidity]

Since the contact angle is large and an appropriate preload is given, high rigidity against torque and moment is achieved.

The support bearing has a contact angle of 30° to secure high rigidity against a moment load, thus to achieve a rigid shaft support.

Model LTR-A, a compact type of LTR, has a contact angle of 45° .

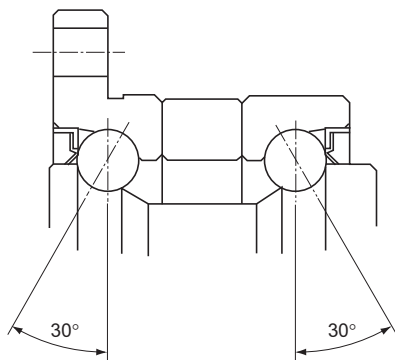

Model LTR

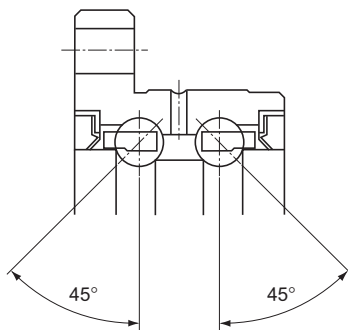

Model LTR-A

Types and Features

[Types of Spline Nuts]

Ball Spline Model LTR

A compact unit type whose support bearings are directly integrated with the outer surface of the spline nut.

Specification Table⇒ [A3-116](#)

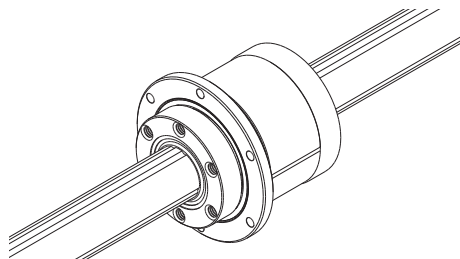

Ball Spline Model LTR-A

A compact type even smaller than LTR.

Specification Table⇒ [A3-114](#)

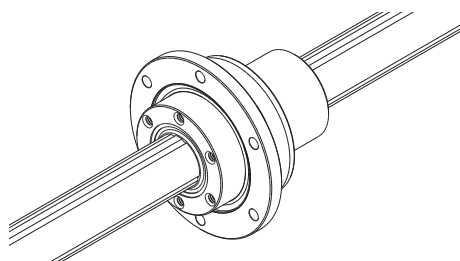

[Types of Spline Shafts]

For details, see [A3-79](#).

Housing Inner-diameter Tolerance

For the housing inner-diameter tolerance for model LTR, class H7 is recommended.

[Important note concerning model LTR]

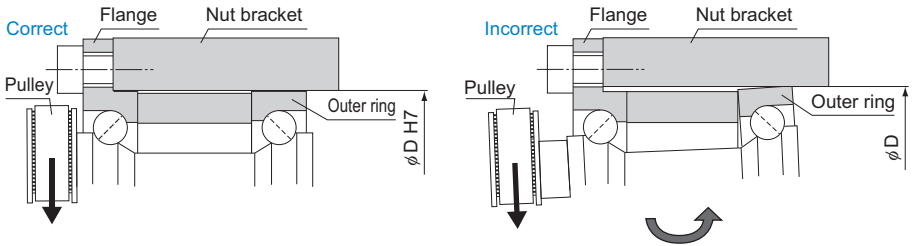

Note) Because of the divided outer ring, it is necessary to incorporate inner-diameter tolerance in the nut bracket (H7 is recommended) to prevent shifting of the outer ring on the side opposite the flange.

Model LTR-A Compact Type

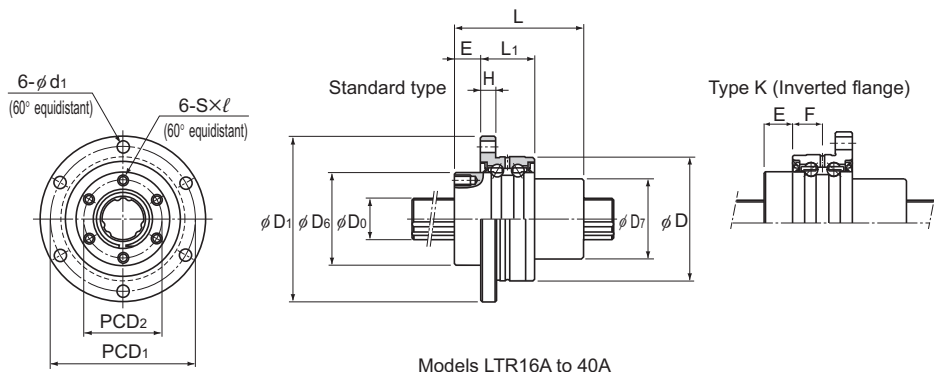

Models LTR16A to 40A

Model No.	Spline nut dimensions														
	Outer diameter		Length L	Flange diameter D ₁	D ₆ h7	D ₇	H	L ₁	Standard type E	Type K E	Lubrication hole position F	E ₁	PCD ₁	PCD ₂	S × l
	D	Tolerance													
LTR8 A	32	-0.009 -0.025	25	44	24	16	3	10.5	6	8.5	4	3	38	19	M2.6 × 3
LTR10 A	36		33	48	28	21	3	10.5	9	11.5	4	—	42	23	M3 × 4
LTR16 A	48	-0.010 -0.029	50	64	36	31	6	21	10	10	10.5	—	56	30	M4 × 6
LTR20 A	56		63	72	43.5	35	6	21	12	12	10.5	—	64	36	M5 × 8
LTR25 A	66	-0.012 -0.034	71	86	52	42	7	25	13	13	12.5	—	75	44	M5 × 8
LTR32 A	78		80	103	63	52	8	25	17	17	12.5	—	89	54	M6 × 10
LTR40 A	100		100	130	79.5	64	10	33	20	20	16.5	—	113	68	M6 × 10

Model number coding

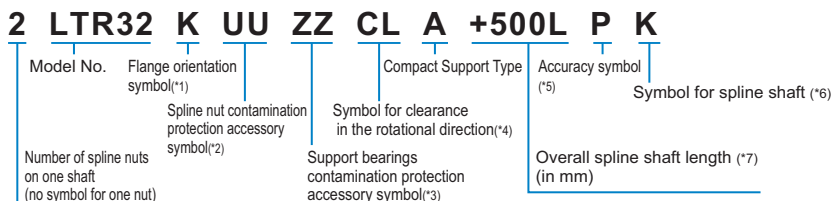

(*2) See **A3-126**. (*3) See **A3-126**. (*4) See **A3-30**. (*5) See **A3-35**. (*6) See **A3-118**. (*7) See **A3-121**.

(*1) No Symbol: standard K: flange inverted

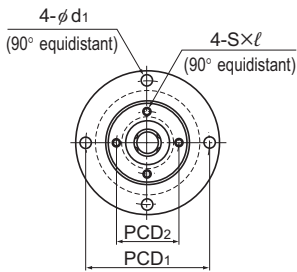

Model LTR8A Model LTR10A

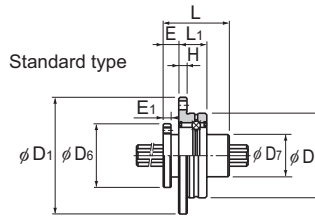

Standard type

Type K (Inverted flange)

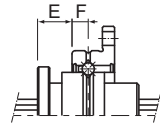

Model LTR8A

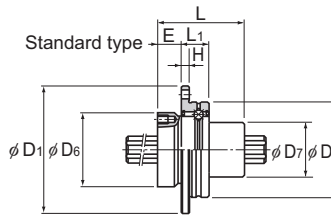

Standard type

Type K (Inverted flange)

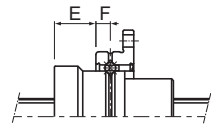

Model LTR10A

Unit: mm

	Spline shaft diameter		Basic torque rating		Basic load rating		Static permissible moment	Support bearing basic load rating		Mass		
	d_1	D_0 h7	Rows of balls	C_T N·m	C_{OT} N·m	C kN		C_0 kN	C kN	C_0 kN	Spline Nut kg	Spline shaft kg/m
	3.4	8	4	1.96	2.94	1.47	2.55	5.9	0.69	0.24	0.08	0.4
	3.4	10	4	3.92	7.84	2.84	4.9	15.7	0.77	0.3	0.13	0.62
	4.5	16	6	31.4	34.3	7.06	12.6	67.6	6.7	6.4	0.35	1.6
	4.5	20	6	56.9	55.9	10.2	17.8	118	7.4	7.8	0.51	2.5
	5.5	25	6	105	103	15.2	25.8	210	9.7	10.6	0.79	3.9
	6.6	32	6	180	157	20.5	34	290	10.5	12.5	1.25	5.6
	9	40	6	419	377	37.8	60.5	687	16.5	20.7	2.51	9.9

Note) ** M_A indicates the permissible moment value in the axial direction when a single spline nut is used, as shown in the figure below.

For details on the maximum lengths of ball spline shafts by accuracy, please see [A3-121](#).

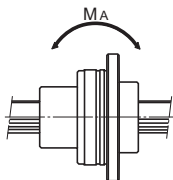

Model LTR

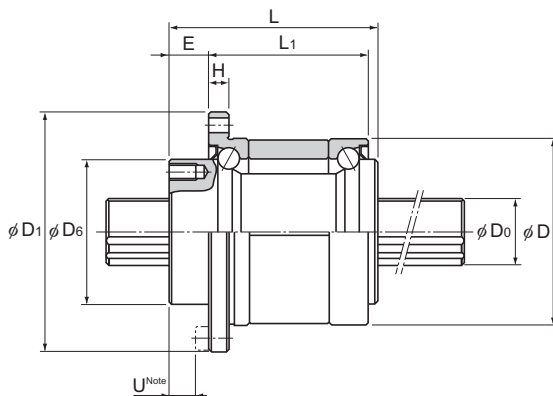
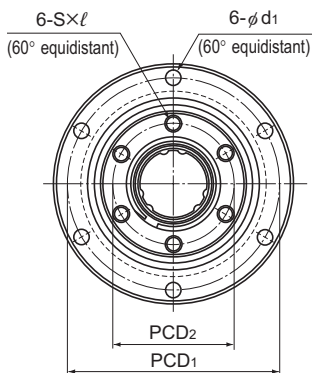

Model No.	Spline nut dimensions										
	Outer diameter		Length L	Flange diameter <i>D</i> ₁	<i>D</i> ₆ h7	H	L ₁	E	PCD ₁	PCD ₂	S× <i>l</i>
	<i>D</i>	Tolerance									
LTR 16	52	0 -0.007	50	68	39.5	5	37	10	60	32	M5×8
LTR 20	56		63	72	43.5	6	48	12	64	36	M5×8
LTR 25	62		71	78	53	6	55	13	70	45	M6×8
LTR 32	80		80	105	65.5	9	60	17	91	55	M6×10
LTR 40	100	0 -0.008	100	130	79.5	11	74	23	113	68	M6×10
LTR 50	120		125	156	99.5	12	97	25	136	85	M10×15
LTR 60	134		140	170	115	12	112	25	150	100	M10×15

Model number coding

2 LTR50 K UU ZZ CM +1000L H K

Model No.	Flange orientation symbol ^(*1)	Symbol for clearance in the rotational direction ^(*4)	Accuracy symbol ^(*5)	Symbol for spline shaft ^(*6)
Number of spline nuts on one shaft (no symbol for one nut)	Spline nut contamination protection accessory symbol ^(*2)	Support bearings contamination protection accessory symbol ^(*3)	Overall spline shaft length ^(*7) (in mm)	

(*2) See **A3-126**. (*3) See **A3-126**. (*4) See **A3-30**. (*5) See **A3-35**. (*6) See **A3-118**. (*7) See **A3-121**.

(*1) No Symbol: standard K: flange inverted

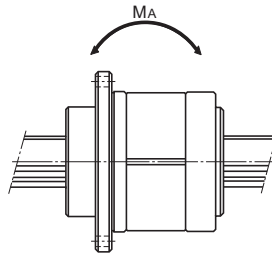

Unit: mm

			Spline shaft diameter		Basic torque rating		Basic load rating		Static permissible moment	Support bearing basic load rating		Mass	
	d_1	U ^{Note)}	D_0 h7	Rows of balls	C_T N·m	C_{0T} N·m	C kN	C_0 kN	M_A^{**} N·m	C kN	C_0 kN	Spline Nut kg	Spline shaft kg/m
	4.5	5	16	6	31.4	34.3	7.06	12.6	67.6	12.7	11.8	0.51	1.6
	4.5	7	20	6	56.9	55.9	10.2	17.8	118	16.3	15.5	0.7	2.5
	4.5	8	25	6	105	103	15.2	25.8	210	17.6	18	0.93	3.9
	6.6	10	32	6	180	157	20.5	34	290	20.1	24	1.8	5.6
	9	13	40	6	419	377	37.8	60.5	687	37.2	42.5	3.9	9.9
	11	13	50	6	842	769	60.9	94.5	1340	41.7	54.1	6.7	15.5
	11	13	60	6	1220	1040	73.5	111.7	1600	53.1	68.4	8.8	22.3

Note) ^{**} M_A indicates the permissible moment value in the axial direction when a single spline nut is used, as shown in the figure above.

Dimension U represents the dimension from the head of the hexagonal-socket-head type bolt to the spline nut end.

For details on the maximum lengths of ball spline shafts by accuracy, please see [A3-121](#).

Spline Shaft

Spline shafts are divided in shape into precision solid spline shaft, special spline shaft and hollow spline shaft (types K and N), as described on **A3-79**.

Since production of a spline shaft with a specific shape is performed at your request, provide a drawing of the desired shaft shape when asking an estimate or placing an order.

[Sectional Shape of the Spline Shaft]

Table1 shows the sectional shape of a spline shaft. If the spline shaft ends need to be cylindrical, the minor diameter (ϕd) value should not be exceeded if possible.

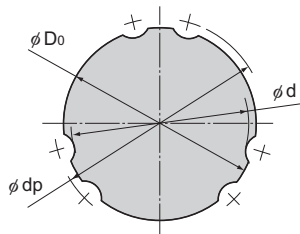

Table1 Sectional Shape of the Spline Shaft

Unit: mm

Nominal shaft diameter	8	10	16	20	25	32	40	50	60
Minor diameter ϕd	7	8.5	14.5	18.5	23	30	37.5	46.5	56.5
Major diameter ϕD_0 h7	8	10	16	20	25	32	40	50	60
Ball center-to-center diameter ϕdp	9.3	11.5	17.8	22.1	27.6	35.2	44.2	55.2	66.3
Mass (kg/m)	0.4	0.62	1.6	2.5	3.9	5.6	9.9	15.5	22.3

*The minor diameter ϕd must be a value at which no groove is left after machining.

[Hole Shape of the Standard Hollow Type Spline Shaft]

Table2 shows the hole shape of the standard hollow type spline shaft (types K and N).

Use this table when a requirement such as piping, wiring, air-vent or weight reduction needs to be met.

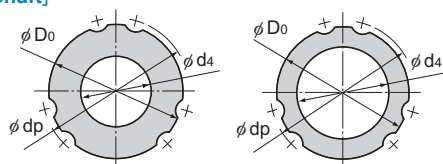

Type K
(Thick)

Type N
(Thin)

Table2 Sectional Shape of the Standard Hollow Type Spline Shaft

Unit: mm

Nominal shaft diameter	8	10	16	20	25	32	40	50	60	
Major diameter ϕD_0 h7	8	10	16	20	25	32	40	50	60	
Ball center-to-center diameter ϕdp	9.3	11.5	17.8	22.1	27.6	35.2	44.2	55.2	66.3	
Type K	Hole diameter ϕd_4	3	4	7	10	12	18	22	25	32
	Mass(kg/m)	0.35	0.52	1.3	1.8	3	4.3	6.9	11.6	16
Type N	Hole diameter ϕd_4	—	—	11	14	18	23	29	36	—
	Mass(kg/m)	—	—	0.8	1.3	1.9	3.1	4.7	7.4	—

Note) The standard hollow type Spline Shaft is divided into types K and N. Indicate "K" or "N" at the end of the model number to distinguish between them when placing an order.

[Chamfering of the Spline Shaft Ends]

To facilitate the insertion of the spline shaft into a spline nut, the shaft ends are normally chamfered with the dimensions indicated below unless otherwise specified.

The ends are chamfered whether they are used, such as with stepped, tapped, or drilled ends, or not used, such as with cantilevered supports.

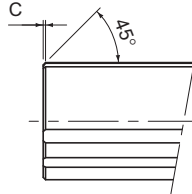

Table 3 Chamfer Dimensions of Model LTR-A and Model LTR Spline Shaft Ends

Unit: mm

Nominal shaft diameter	8	10	16	20	25	32	40	50	60
Chamfer C	0.5	0.5	0.5	0.5	0.5	0.5	1	1	2

[Length of Incomplete Area of a Special Spline Shaft]

If the middle area or the end of a spline shaft is to be thicker than the minor diameter (ϕd), an imperfect spline area is required to secure a recess for grinding. Table 4 shows the relationship between the length of the incomplete section (S) and the flange diameter (ϕdf).

(This table does not apply to overall length of 1,500 mm or greater. Contact THK for details.)

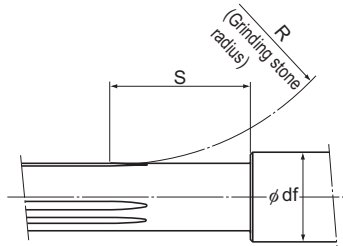

Table 4 Length of Incomplete Spline Area: S

Unit: mm

Flange diameter ϕdf	6	8	10	13	16	20	25	30	40	50	60	80	100	120	140	160
Nominal shaft diameter																
8	—	25	29	35	41	—	—	—	—	—	—	—	—	—	—	—
10	—	—	26	31	38	45	—	—	—	—	—	—	—	—	—	—
16	—	—	—	—	36	47	58	67	—	—	—	—	—	—	—	—
20	—	—	—	—	—	37	50	60	76	—	—	—	—	—	—	—
25	—	—	—	—	—	—	38	51	72	88	—	—	—	—	—	—
32	—	—	—	—	—	—	—	—	40	75	88	109	—	—	—	—
40	—	—	—	—	—	—	—	—	42	63	81	107	—	—	—	—
50	—	—	—	—	—	—	—	—	—	45	65	96	118	—	—	—
60	—	—	—	—	—	—	—	—	—	—	50	87	114	134	—	—

Permissible Rotational Speed for Rotary Ball Splines

For model LTR rotary ball splines, the speed is restricted by whichever is lower of the support bearing permissible rotational speed and the critical speed of the spline. When using the product, do not exceed the permissible rotational speed.

Table5 Model LTR permissible rotational speed

Unit:min⁻¹

Model No.	Permissible Rotational Speed		
	Ball spline	Support bearing	
	Calculated using shaft length	Grease Lubrication	Oil Lubrication
LTR16	see A3-16 .	4000	5400
LTR20		3200	4300
LTR25		2800	3700
LTR32		2400	3300
LTR40		2000	2700
LTR50		1600	2200
LTR60		1400	2000

Table6 Model LTR-A permissible rotational speed

Unit:min⁻¹

Model No.	Permissible Rotational Speed		
	Ball spline	Support bearing	
	Calculated using shaft length	Grease Lubrication	Oil Lubrication
LTR8A	see A3-16 .	6900	9300
LTR10A		5900	7900
LTR16A		4000	5400
LTR20A		3500	4700
LTR25A		2900	3900
LTR32A		2400	3300
LTR40A		1900	2600

Dimensional Drawing, Dimensional Table

Maximum Manufacturing Length by Accuracy

Maximum Manufacturing Length by Accuracy

Table1, Table2, Table3 and Table4 show the maximum manufacturing lengths of ball spline shafts by accuracy.

Table1 Maximum Manufacturing Length of Models SLS, SLS-L and SLF

Unit: mm

Nominal shaft diameter	Accuracy		
	Normal grade (No symbol)	High accuracy grade (H)	Precision Grade (P)
25	2000	1500	1000
30	2000	1600	1250
40	2000	2000	1500
50	3000	2000	1500
60	4000	2000	2000
70	4000	2000	2000
80	4000	2000	2000
100	4000	3000	3000

Table2 Maximum Manufacturing Length of Models LBS, LBST, LBF, LBR, LBH, LBG and LBGT by Accuracy

Unit: mm

Nominal shaft diameter	Accuracy		
	Normal grade (No symbol)	High accuracy grade (H)	Precision Grade (P)
15	1800	600	600
20	1800	700	700
25	3000	1400	1400
30	3000	1400	1400
40	3000	1400	1400
50	3000	1400	1400
60	3800	2500	2000
70	3800	2500	2000
85	3800	3000	3000
100	4000	3000	3000
120	3000	3000	3000
150	3000	3000	3000

Table3 Maximum Manufacturing Length of Models LT-X, LF-X, LFK-X, and LFH-X by Accuracy Unit: mm

Nominal shaft diameter	Accuracy		
	Normal grade (No symbol)	High accuracy grade (H)	Precision Grade (P)
4	200	200	200
5	250	200	200
6	315	250	200
8	500	400	315
10	1000	630	500
13	1000	800	630
16	2000	1000	1000
20	2000	1500	1000
25	3000	1500	1000
30	3000	1600	1250

Table4 Maximum Manufacturing Length of Models LT, LF, LTR, and LTR-A by Accuracy Unit: mm

Nominal shaft diameter	Accuracy		
	Normal grade (No symbol)	High accuracy grade (H)	Precision Grade (P)
4	600	200	200
5	600	315	200
6	600	400	315
8	1000	500	400
10	1000	630	500
13	1000	800	630
16	2000	1000	1000
20	2000	1500	1000
25	3000	1500	1000
30	3000	1600	1250
32	3000	1600	1250
40	3000	2000	1520
50	3000	2000	1500
60	4000	2000	2000
80	4000	2000	2000
100	4000	3000	3000

1. The length in the table represents the overall shaft length.
2. With standard hollow shaft type (K), the values in the table apply.
3. With standard hollow shaft type (N), the available maximum length for both the normal grade and the high accuracy grade is up to the length defined for the precision grade in the table.

Checking List for Spline Shaft End Shape

If desiring a ball spline type with its end specially machined, check the following items when placing an order.

The diagram below shows a basic configuration of the Ball Spline.

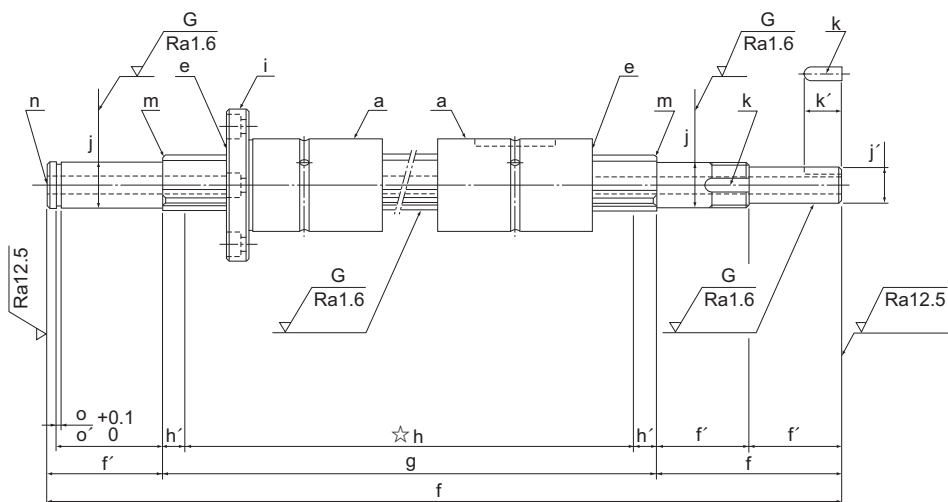

[Check Items]

- Type of the spline nut to be fit
- Number of spline nuts
- Clearance in the rotation direction
- Accuracy
- With/without a seal (for a single seal, check its orientation)
- Overall length (including all dimensions? Total value correct?)
- Effective spline length
- Hardened area (mark the location with symbol \star and indicate the purpose of hardening)
- Orientation of the flange (for flanged type)
- Spline shaft end shape (thicker than the minimum spline diameter?) (black, mill scale)
- Positional relationship between the spline nut and the spline shaft end shape (keyway of the spline nut, flange mounting hole)
- Indication of chamfering for each part
- Shape of chamfer on the spline shaft end (see **A3-70**)
- Intended purpose of the though hole in the spline shaft if any
- o'. Snap ring groove
- p. Maximum length
- q. Precedented or not

Housing Inner-diameter Tolerance

When fitting the spline nut to the housing, tight fitting is normally recommended. If the accuracy of the Ball Spline does not need to be very high, clearance fitting is also acceptable.

Table1 Housing Inner-diameter Tolerance

Housing Inner-diameter Tolerance	General conditions	H7
	When clearance needs to be small	J6

Note) For the housing inner-diameter tolerance of Rotary Ball Spline model LTR, H7 is recommended.

Positions of the Spline-nut Keyway and Mounting Holes

The keyways formed on the outer surface of straight nuts for Ball Spline models are positioned where balls under a load are placed as shown in Fig.1.

The flange-mounting holes of the flange types are positioned as shown in Fig.2.

When placing an order, indicate their positions in relation to the keyway or the like to be formed on the spline shaft.

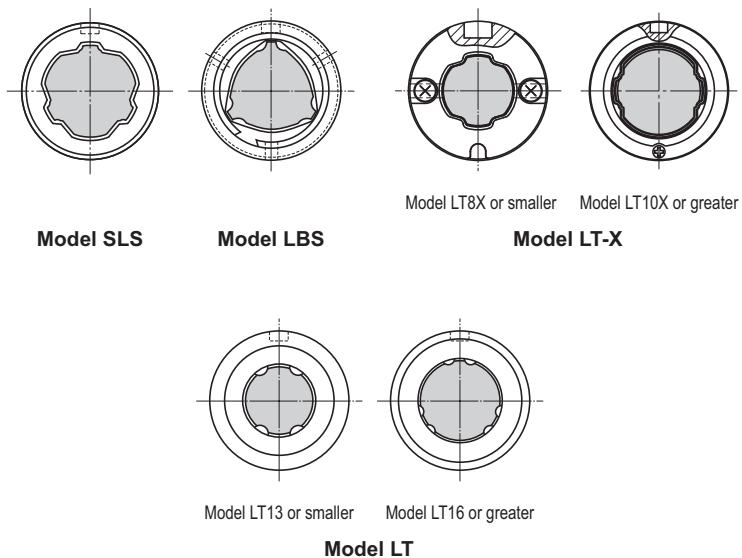
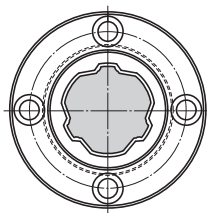

Fig.1 Positions of Keyways

Point of Design

Positions of the Spline-nut Keyway and Mounting Holes



Model SLF

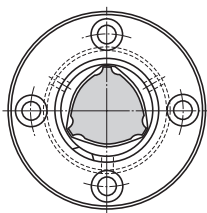

Model LBF

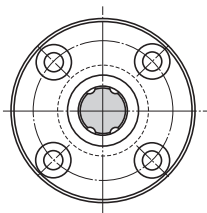

Model LF13 or smaller

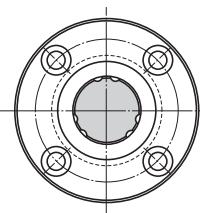

Model LF16 or greater

Model LF

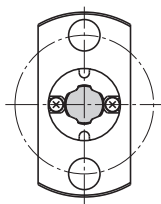

Model LF4X

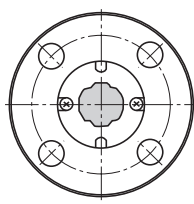

Models LF5X to 8X

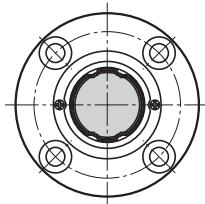

Model LF10X or greater

Model LF-X

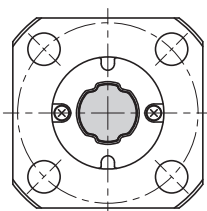

Model LFK8X or smaller

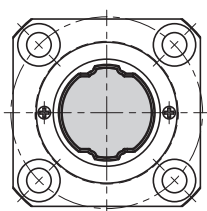

Model LFK10X or greater

Model LFK-X

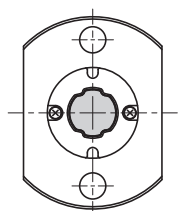

Model LFH13X or smaller

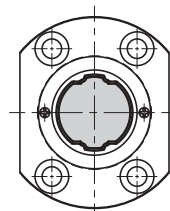

Model LFH16X or greater

Model LFH-X

Fig.2 Positions of Flange Mounting Holes

Lubrication

To prevent foreign material from entering the spline nut and the lubricant from leaking, special synthetic resin seals with high wear resistance are available for the Ball Spline.

Spline nuts with seals (UU seals for both ends and seals for one end) contain lithium soap-based grease No. 2. If using at high speed or with a long stroke, replenish grease of the same type through the lubrication hole on the spline nut after running in.

Afterward, replenish grease of the same type as necessary according to the service conditions.

The greasing interval differs depending on the conditions. Normally, replenish the lubricant (or replace the product) roughly every 100 km of travel distance (three to six months) as a rule of thumb.

For a Ball Spline model type without a seal, apply grease to the interior of the spline nut or to the raceways of the spline shaft.

Material and Surface Treatment

Depending on the service environment, the Ball Spline requires anticorrosive treatment or a different material. For details of anticorrosive treatment and material change, contact THK.

Contamination Protection

Entrance of dust or other foreign material into the spline nut will cause abnormal wear or shorten the service life. Therefore, it is necessary to prevent detrimental foreign material from entering the Ball Spline. When entrance of dust or other foreign material is a possibility, it is important to select effective seals and/or dust-control device that meets the environment conditions.

For the Ball Spline, a special synthetic rubber seal that is highly resistant to wear is available as a contamination protection accessory. If desiring a higher contamination protection effect, a felt seal is also available for some types. For details about the felt seal, contact THK.

In addition, THK produces round bellows. Contact us for details.

Table1 Dust prevention accessory symbol

Symbol	Contamination protection accessory
No Symbol	Without seal
UU	Rubber seal attached on both ends of spline nut
U	Rubber seal attached on either end of spline nut
DD	Felt seal attached on both ends of spline nut
D	Felt seal attached on either end of spline nut
ZZ	Rubber seal attached on both ends of support bearings
Z	Rubber seal attached on either end of support bearings

Specifications of the Bellows

Bellows are available as a contamination protection accessory. Use this specification sheet.

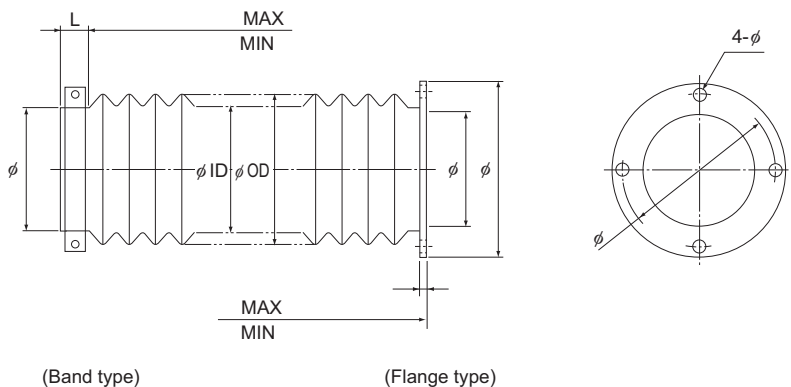

Specifications of the Bellows

Supported Ball Spline models:

Dimensions of the Bellows

Stroke: () mm MAX: () mm MIN: () mm

Permissible outer diameter: (ϕ OD) Desired inner diameter: (ϕ ID)

How It Is Used

Installation direction: (horizontal, vertical, slant) Speed: () m/s or m/min

Motion: (reciprocation, vibration)

Conditions

Resistance to oil and water: (necessary, unnecessary) Oil name ()

Chemical resistance: Name () \times () %

Location: (indoor, outdoor)

Remarks:

Number of Units To Be Manufactured:

Model Number Coding

Model number configurations differ depending on the model features. Refer to the corresponding sample model number configuration.

[Ball Spline]

- Models SLS, SLS-L, SLF, LBS, LBST, LBF, LBR, LBH, LT, LF, LT-X, LF-X, LFK-X and LFH-X

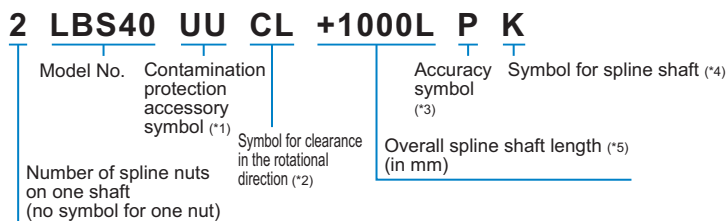

(*1) See [A3-126](#). (*2) See [A3-30](#). (*3) See [A3-35](#). (*4) See [A3-69](#). (*5) See [A3-121](#).

[Rotary Ball Spline]

- Models LTR, LTR-A, LBG and LBGT

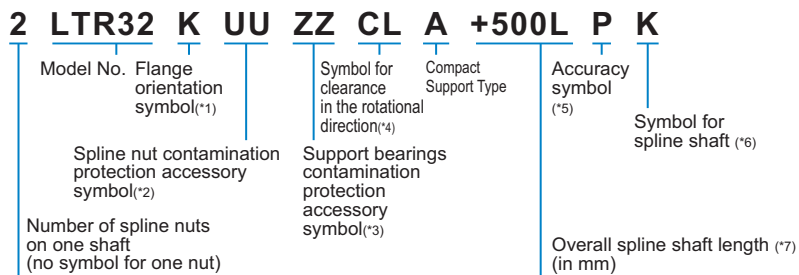

(*1) See [A3-126](#). (*2) See [A3-126](#). (*3) See [A3-30](#). (*4) See [A3-35](#). (*5) See [A3-118](#). (*6) See [A3-121](#).

(*1) No Symbol: standard K: flange inverted

Precautions on Use

Ball Spline

[Handling]

- (1) Please use at least two people to move any product weighing 20 kg or more, or use a dolly or another conveyance. Doing so may cause injury or damage.
- (2) Do not disassemble the parts. This will result in loss of functionality.
- (3) Tilting a spline nut or spline shaft may cause them to fall by their own weight.
- (4) Take care not to drop or strike the Ball Spline. Doing so may cause injury or damage. Giving an impact to it could also cause damage to its function even if the product looks intact.
- (5) When assembling, do not remove the spline nut from the spline shaft.
- (6) When handling the product, wear protective gloves, safety shoes, etc., as necessary to ensure safety.

[Precautions on Use]

- (1) Prevent foreign material, such as cutting chips or coolant, from entering the product. Failure to do so may cause damage.
- (2) If the product is used in an environment where cutting chips, coolant, corrosive solvents, water, etc., may enter the product, use bellows, covers, etc., to prevent them from entering the product.
- (3) Do not use the product at temperature of 80°C or higher. Except for the heat-resistant models, exposure to higher temperatures may cause the resin/rubber parts to deform/be damaged.
- (4) If foreign material such as cutting chips adheres to the product, replenish the lubricant after cleaning the product.
- (5) Micro-strokes tend to obstruct oil film to form on the raceway in contact with the rolling element, and may lead to fretting corrosion. Take consideration using grease offering excellent fretting prevention. It is also recommended that a stroke movement corresponding to the length of the spline nut be made on a regular basis to make sure oil film is formed between the raceway and rolling element.
- (6) Do not use undue force when fitting parts (pin, key, etc.) to the product. This may generate permanent deformation on the raceway, leading to loss of functionality.
- (7) Skewing or misalignment of the spline shaft support and spline nut can shorten service life substantially. Inspect the components carefully and make sure they are mounted correctly.
- (8) The spline nut must contain all its internal rolling elements (balls) when mounted on the spline shaft. Using a spline nut with any balls removed may result in premature damage.
- (9) Please contact THK if any balls fall out of the spline nut; do not use the spline nut if any balls are missing.
- (10) To mount the spline nut on the spline shaft, first locate the alignment indicators on both components, then insert the shaft through the opening in the spline nut, without forcing it, and adjust the position until the indicators are aligned. Forcing the shaft could cause balls to fall out. When mounting a spline nut equipped with a seal or preload, first lubricate the outer surface of the spline shaft.
- (11) Manipulate the spline nut gently, using a jig, when inserting it into the housing, taking care not to strike the side plate, end cap, or seal.
- (12) If an attached component is insufficiently rigid or mounted incorrectly, the bearing load will be concentrated at one location and performance will decline significantly. Make sure the housing and base are sufficiently rigid, the anchoring bolts are strong enough, and the component is mounted correctly.
- (13) If desiring to have a flanged-type Ball Spline additionally machined, such as having a dowel pin hole, contact THK.

[Lubrication]

- (1) Thoroughly wipe off anti-rust oil and feed lubricant before using the product.
- (2) Do not combine different lubricants. Mixing lubricants can cause adverse interaction between disparate additives or other ingredients.
- (3) If the product will be exposed to constant vibration or high or low temperatures, or used in a clean room, vacuum, or other special environment, apply a lubricant suitable for both the specifications and the environment.
- (4) To lubricate a product that has no grease nipple or lubrication hole, apply lubricant directly to the raceway surface and execute a few preliminary strokes to ensure that the interior is fully lubricated.
- (5) Bear in mind that the Ball Spline's slide resistance is affected by changes in the consistency of the lubricant, which varies according to the temperature.
- (6) The Ball Spline may encounter increased slide resistance following lubrication, due to the lubricant's agitation resistance. Make sure to put the unit through some preliminary motions to ensure that it is fully lubricated before starting up the machine.
- (7) Excess lubricant may spatter immediately after lubrication. If necessary, wipe off any spattered grease.
- (8) Because lubricant performance declines over time, lubrication must be monitored regularly and fresh lubricant applied when needed, depending on how frequently the machine is operated.
- (9) The appropriate lubrication schedule will depend on usage conditions and the surrounding environment. In general, the unit should be lubricated after every 100 kilometers of operation (every 3 to 6 months). The actual lubrication schedule and amount of lubricant used should be determined by the condition of the machinery.
- (10) With oil lubrication, the lubricant may not always be thoroughly disseminated inside the Ball Spline, depending on its mounting position. If the preferred lubrication method is oil lubrication, please consult THK in advance.

[Storage]

When storing the Ball Spline, enclose it in a package designated by THK and store it in a room in a horizontal orientation while avoiding high temperature, low temperature and high humidity. After the product has been in storage for an extended period of time, lubricant inside may have deteriorated, so add new lubricant before use.

[Disposal]

Dispose of the product properly as industrial waste.



Ball Spline

THK General Catalog

Ball Spline

THK General Catalog

B Support Book

Features and Types	B 3-4
Features of the Ball Spline	B 3-4
• Structure and Features	B 3-4
Classification of Ball Splines.....	B 3-6
Point of Selection	B 3-8
Flowchart for Selecting a Ball Spline.....	B 3-8
• Steps for Selecting a Ball Spline	B 3-8
• Selecting a Type	B 3-10
• Studying the Spline Shaft Strength	B 3-14
• Predicting the Service Life.....	B 3-19
• Example of Calculating the Service Life....	B 3-25
Mounting Procedure and Maintenance ..	B 3-31
Assembling the Ball Spline	B 3-31
• Mounting the Spline	B 3-31
• Installing the Spline Nut	B 3-33
• Installation of the Spline Shaft.....	B 3-33
Lubrication	B 3-34
Options	B 3-35
Material and Surface Treatment	B 3-35
Contamination Protection	B 3-35
Model No.	B 3-36
• Model Number Coding	B 3-36
Precautions on Use	B 3-37

A Product Descriptions (Separate)

Classification of Ball Splines..... **A3-4**

Point of Selection **A3-6**

Flowchart for Selecting a Ball Spline..... **A3-6**

- Steps for Selecting a Ball Spline **A3-6**
- Selecting a Type **A3-8**
- Studying the Spline Shaft Strength **A3-12**
- Predicting the Service Life **A3-20**

Selecting a Preload **A3-30**

- Clearance in the Rotation Direction **A3-30**
- Preload and Rigidity **A3-30**
- Conditions and Guidelines for Selecting of a Preload .. **A3-31**

Determining the Accuracy..... **A3-34**

- Accuracy Grades **A3-34**
- Accuracy Standards **A3-35**

High Torque Caged Ball Spline

Models SLS, SLS-L and SLF..... **A3-38**

- Structure and Features **A3-39**
- Types and Features **A3-42**
- Housing Inner-diameter Tolerance **A3-43**

Dimensional Drawing, Dimensional Table

Model SLS **A3-44**

Model SLF **A3-46**

- Spline Shaft **A3-48**
- Accessories **A3-50**

High Torque Type Ball Spline

Models LBS, LBST, LBF, LBR and LBH .. **A3-52**

- Structure and Features **A3-53**
- Applications **A3-54**
- Types and Features **A3-55**
- Housing Inner-diameter Tolerance **A3-57**

Dimensional Drawing, Dimensional Table

Model LBS (Medium Load Type)..... **A3-58**

Model LBST (Heavy Load Type) **A3-60**

Model LBF (Medium Load Type) **A3-62**

Model LBR **A3-64**

Model LBH **A3-66**

Model LBS with Recommended Shaft End Shape .. **A3-68**

- Spline Shaft **A3-69**
- Accessories **A3-72**

Medium Torque Type Ball Spline

Models LT, LF, LT-X, LF-X, LFK-X, and LFH-X .. **A3-74**

- Structure and Features **A3-75**
- Types and Features **A3-76**
- Housing Inner-diameter Tolerance **A3-79**

Dimensional Drawing, Dimensional Table

Model LT **A3-80**

Model LF **A3-82**

Model LT-X **A3-84**

Model LF-X **A3-86**

Model LFK-X **A3-88**

Model LFH-X **A3-90**

Model LT with Recommended Shaft End Shape .. **A3-92**

- Spline Shaft **A3-93**
- Accessories **A3-97**

Rotary Ball Spline

With Geared Type Models LBG and LBGT .. **A3-98**

- Structure and Features **A3-99**
- Types and Features **A3-100**
- Housing Inner-diameter Tolerance **A3-101**

Dimensional Drawing, Dimensional Table

Model LBG **A3-102**

Model LBGT **A3-104**

- Spline Shaft **A3-106**

Rotary Ball Spline

With Support Bearing Type Models LTR and LTR-A.. **A3-110**

- Structure and Features **A3-111**
- Types and Features **A3-112**
- Housing Inner-diameter Tolerance **A3-113**

Dimensional Drawing, Dimensional Table

Model LTR-A Compact Type..... **A3-114**

Model LTR **A3-116**

- Spline Shaft **A3-118**

- Permissible Rotational Speed for Rotary Ball Splines .. **A3-120**

Maximum Manufacturing Length by Accuracy .. **A3-121**

Point of Design **A3-123**

Checking List for Spline Shaft End Shape .. **A3-123**

Housing Inner-diameter Tolerance **A3-124**

Positions of the Spline-nut Keyway and Mounting Holes .. **A3-124**

Options **A3-126**

Lubrication **A3-126**

Material and Surface Treatment **A3-126**

Contamination Protection **A3-126**

- Specifications of the Bellows **A3-127**

Model No. **A3-128**

- Model Number Coding..... **A3-128**

Precautions on Use **A3-129**

Features of the Ball Spline

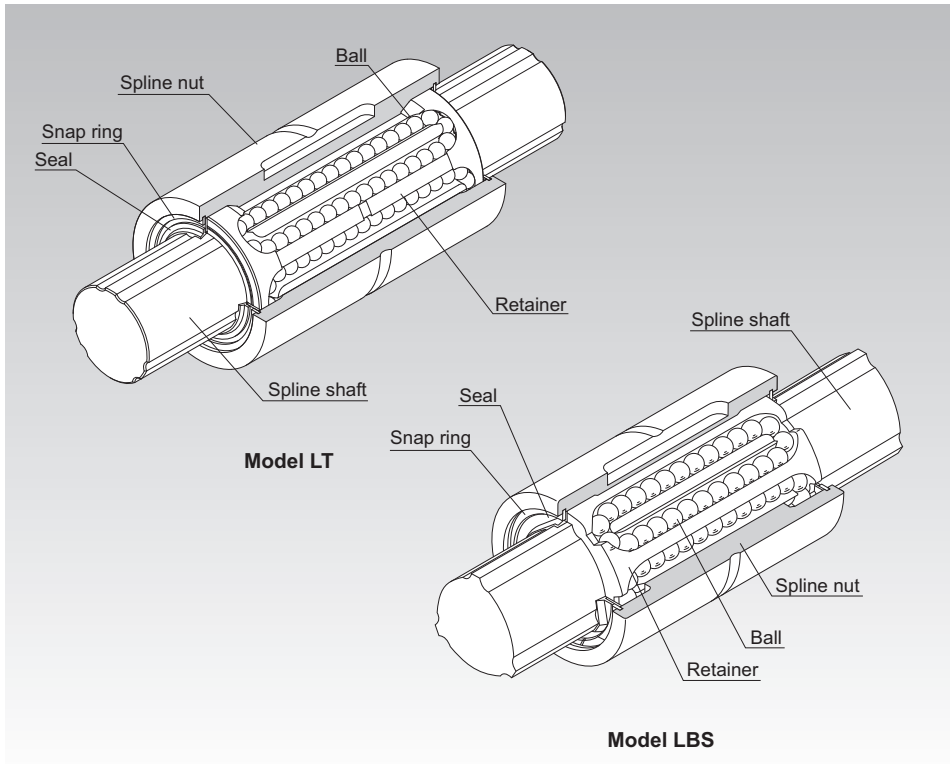

Fig.1 Structure of Ball Spline Models LBS and LT

Structure and Features

The Ball Spline is an innovative linear motion system in which balls accommodated in the spline nut transmit torque while linearly moving on precision-ground raceways on the spline shaft.

Unlike the conventional structure, a single spline nut can provide a preload with THK's Ball Spline. As a result, the Ball Spline demonstrates high performance in environments subject to vibrations and impact loads, locations where a high level of positioning accuracy is required or areas where high-speed kinetic performance is required.

In addition, even when used as an alternative to a linear bushing, the Ball Spline achieves a rated load more than 10 times greater than the linear bushing with the same shaft diameter, allowing it to compactly be designed and used in locations where an overhung load or a moment load is applied. Thus, the Ball Spline provides a high degree of safety factor and long service life.

Features and Types

Features of the Ball Spline

Classification of Ball Splines

Ball Spline

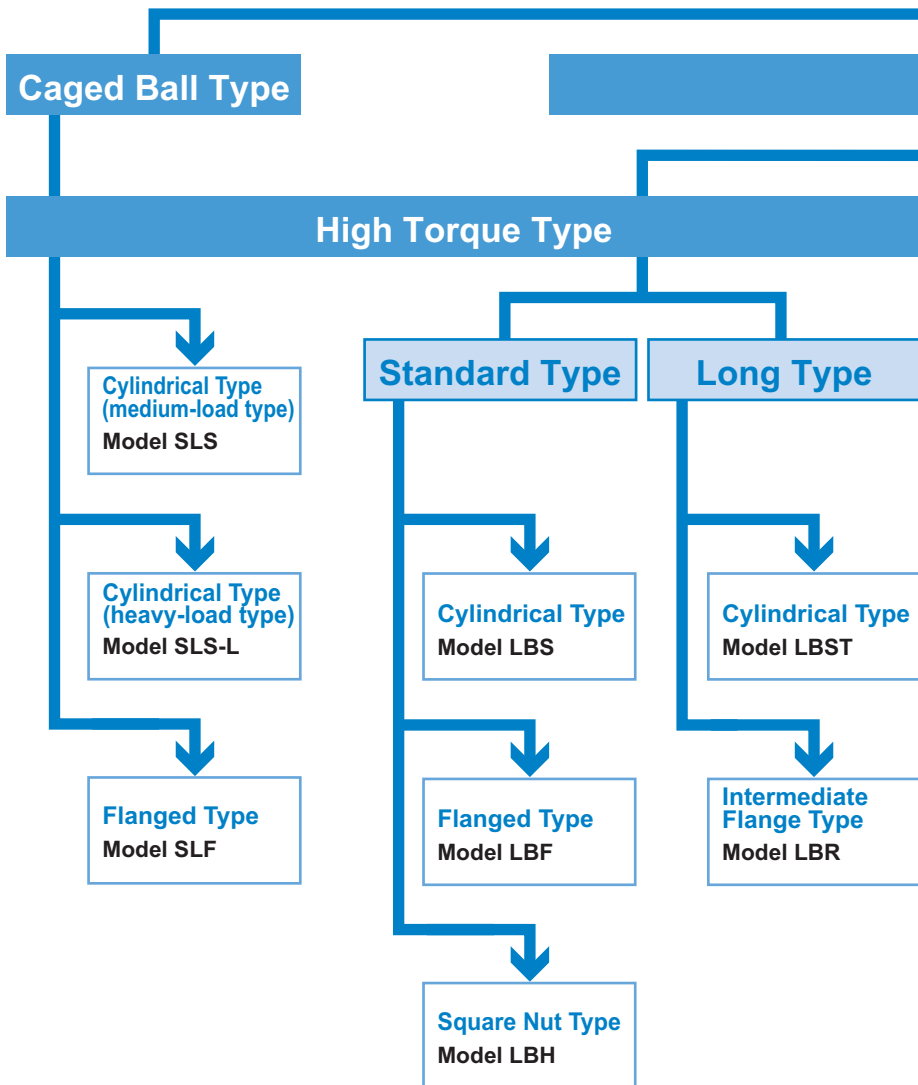

Full-ball Type

Medium torque Type

Standard Type

Cylindrical Type
Model LT

Flanged Type
Model LF

Compact Type

Cylindrical Type
Model LT-X

Flanged Type
Model LF-X

Flanged Type
Model LFK-X

Flanged Type
Model LFH-X

Rotary Type

Geared Type

Standard Type
Model LBG

Thrust Raceway
Type
Model LBG-T

Support Bearing Type

Standard Type
Model LTR

Compact Type
Model LTR-A

Flowchart for Selecting a Ball Spline

Steps for Selecting a Ball Spline

The following is a flowchart to reference when selecting a Ball Spline.

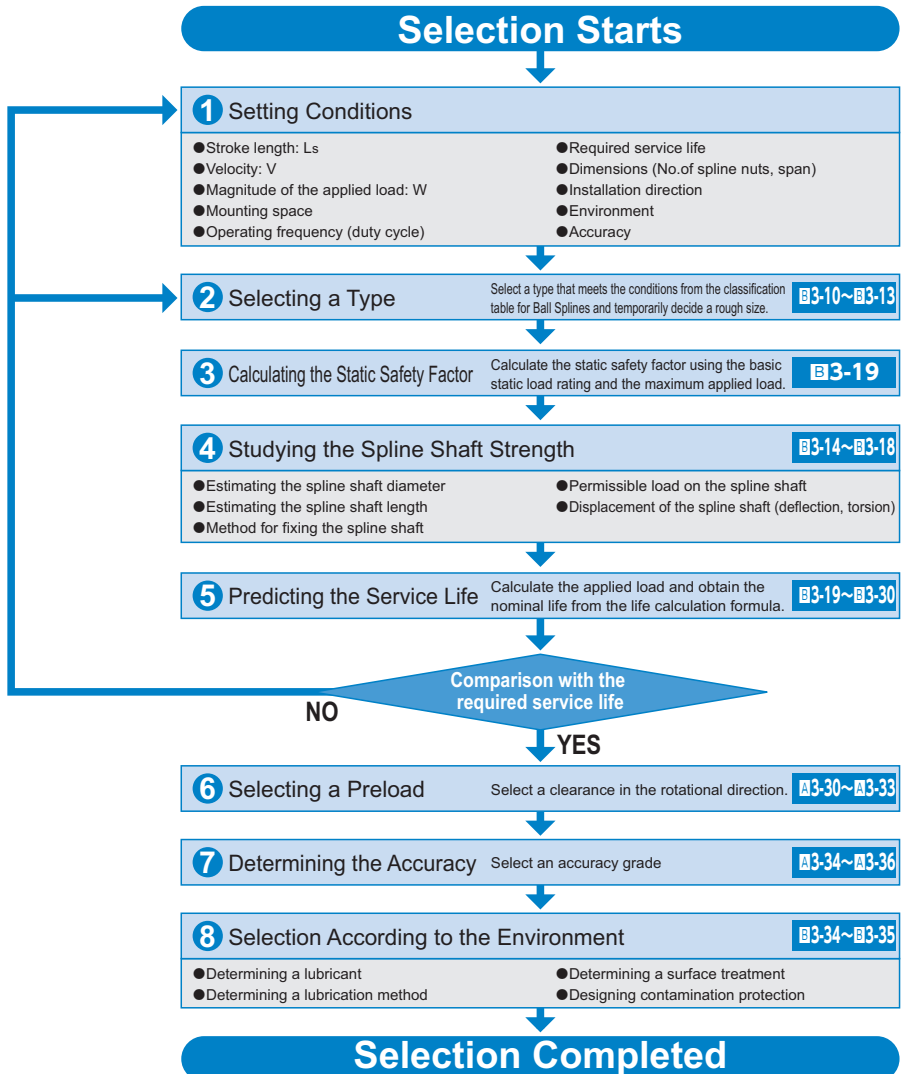



Point of Selection

Flowchart for Selecting a Ball Spline



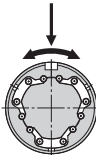
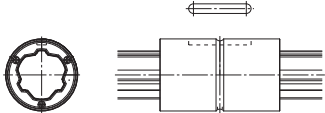
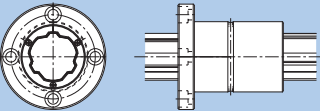
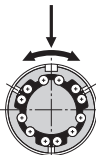
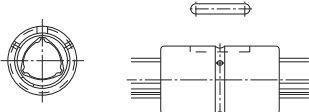
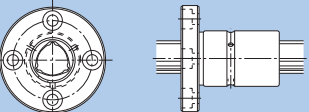
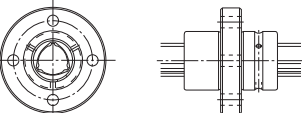







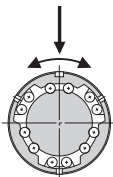

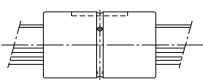

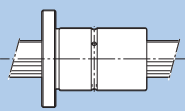
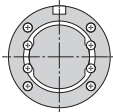

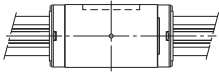
Selecting a Type

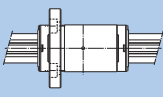
There are three types of the Ball Spline: high torque type, medium torque type and rotary type. You can choose a type according to the intended use. In addition, wide arrays of spline nut shapes are available for each type, enabling the user to choose a desired shape according to the mounting or service requirements.

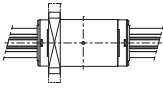
Classification		Type	Shape	Shaft diameter
High torque Caged Ball type		Type SLS Type SLS-L		Nominal shaft diameter 25 to 100 mm
		Type SLF		Nominal shaft diameter 25 to 100 mm
High torque type		Type LBS Type LBST		Nominal shaft diameter 15 to 150 mm
		Type LBF		Nominal shaft diameter 15 to 100 mm
		Type LBR		Nominal shaft diameter 15 to 100 mm
		Type LBH		Nominal shaft diameter 15 to 50 mm

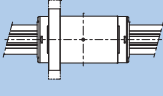
*For the specification table for each model, please see "Product Descriptions."

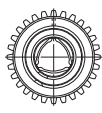
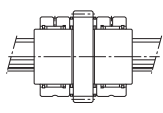
Specification Table*	Structure and features	Major application
A3-44	<ul style="list-style-type: none"> ● Redesigning the shape of the conventional high torque type spline shaft to be more circular significantly improves its torsion and flexural rigidity. ● Models SLS/SLF adopt the caged-ball technology to enable the circulating motion of evenly spaced balls to be maintained and high-speed response to be achieved, the cycle time of the machine can be improved. ● Models SLS/SLF adopt the caged-ball technology, they eliminate collision and mutual friction between balls, and realize low noise, pleasant running sound and low particle generation. ● Models SLS/SLF adopt the caged-ball technology to substantially increase the grease retention, thus achieving long-term maintenance-free operation. ● Models SLS/SLF adopt the caged-ball technology and a new circulation method, thus achieving stable and smooth motion with small rolling fluctuation. 	<ul style="list-style-type: none"> ● Column and arm of industrial robot ● Automatic loader ● Transfer machine ● Automatic conveyance system ● Tire molding machine ● Spindle of spot-welding machine ● Guide shaft of high-speed automatic coating machine ● Riveting machine ● Wire winder ● Work head of electric discharge machine ● Spindle drive shaft of grinding machine ● Speed gears ● Precision indexing machine
A3-46		
A3-58	<ul style="list-style-type: none"> ● The spline shaft has three crests equidistantly formed at angles of 120°. On both sides of each crest, two rows (six rows in total) of balls are arranged to hold the crest from both sides. The angular-contact design of the ball contact areas allows an appropriate preload to be evenly applied. ● Since the balls circulate inside the spline nut, the outer dimensions of the spline nut are compactly designed. ● Even under a large preload, smooth straight motion is achieved. ● Since the contact angle is large (45°) and the displacement is minimal, high rigidity is achieved. ● No angular backlash occurs. ● Capable of transmitting a large torque. 	
A3-62		
A3-64		
A3-66		

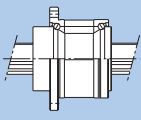
Classification		Type	Shape		Shaft diameter
Medium torque type		Type LT			Nominal shaft diameter 4 to 100 mm
		Type LF			Nominal shaft diameter 6 to 50 mm
		Type LT-X			Nominal shaft diameter 4 to 30 mm
		Type LF-X			Nominal shaft diameter 4 to 30 mm
		Type LFK-X			Nominal shaft diameter 5 to 30 mm
		Type LFH-X			Nominal shaft diameter 5 to 30 mm
Rotary type	Rotation 	Type LBG Type LBGT			Nominal shaft diameter 20 to 85 mm
	Rotation 	Type LTR-A Type LTR			Nominal shaft diameter 8 to 60 mm

*For the specification table for each model, please see "A Product Descriptions."

Point of Selection

Selecting a Type

Specification Table*	Structure and features	Major application	
A3-80	<ul style="list-style-type: none"> The spline shaft has two to three crests. On both sides of each crest, two rows (four to six rows in total) of balls are arranged to hold the crest from both sides. This design allows an appropriate preload to be evenly applied. The contact angle of 20° and an appropriate preload level eliminate angular backlash, providing high-torque moment rigidity. 	<ul style="list-style-type: none"> Die-set shaft and similar applications requiring straight motion under a heavy load Loading system and similar applications requiring rotation to a given angle at a fixed position Automatic gas-welding machine spindle and similar applications requiring a whirl-stop on one shaft 	<ul style="list-style-type: none"> Column and arm of industrial robot Spot-welding machine Riveting machine Book-binding machine Automatic filler XY recorders Automatic spinner Optical measuring instrument
A3-82			
A3-84	<ul style="list-style-type: none"> The length and external diameter of the LT-X ball spline's outer cylinder are the same as those of an LM-series linear bushing, meaning the nut can be replaced with a linear bushing. 		
A3-86	<ul style="list-style-type: none"> The length and external diameter of the LF-X ball spline's nut are the same as those of the Model LMF linear bushing, meaning the nut can be replaced with a linear bushing. 		
A3-88	<ul style="list-style-type: none"> The Model LFK-X is a lightweight and compact product designed with a lower core height than the Model LF-X. 		
A3-90	<ul style="list-style-type: none"> The Model LFH-X is a lightweight and compact product designed with a lower core height than the Model LFK-X. 		
A3-102	<ul style="list-style-type: none"> A unit type that has the same contact structure as model LBS. The flange circumference on the spline nut is machined to have gear teeth, and radial and thrust needle bearings are compactly combined on the circumference of the spline nut. 	<ul style="list-style-type: none"> Speed gears for high torque transmission 	
A3-114	<ul style="list-style-type: none"> A lightweight and compact type based on model LT, but has a spline nut circumference machined to have angular-contact type ball raceways to accommodate support bearings. 	<ul style="list-style-type: none"> Z axis of scalar robot Wire winder 	

Studying the Spline Shaft Strength

The spline shaft of the Ball Spline is a compound shaft capable of receiving a radial load and torque. When the load and torque are large, the spline shaft strength must be taken into account.

[Spline Shaft Receiving a Bending Load]

When a bending load is applied to the spline shaft of a Ball Spline, obtain the spline shaft diameter using the equation (1) below.

$$M = \sigma \cdot Z \quad \text{and} \quad Z = \frac{M}{\sigma} \quad \dots\dots\dots(1)$$

M : Maximum bending moment acting on the spline shaft (N·mm)

σ : Permissible bending stress of the spline shaft (98 N/mm²)

Z : Modulus section factor of the spline shaft (mm³)

(see Table3 on **A3-17**, Table4 on **A3-18**, Table5 on **A3-19** and Table6 on **A3-20**)

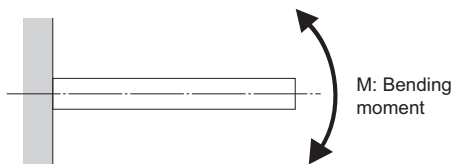

[Reference] Section Modulus (Solid Circle)

$$Z = \frac{\pi \cdot d^3}{32}$$

Z : Section Modulus (mm³)

d : Shaft outer diameter (mm)

[Spline Shaft Receiving a Torsion Load]

When a torsion load is applied on the spline shaft of a Ball Spline, obtain the spline shaft diameter using the equation (2) below.

$$T = \tau_a \cdot Z_P \quad \text{and} \quad Z_P = \frac{T}{\tau_a} \quad \dots\dots\dots(2)$$

T : Maximum torsion moment (N·mm)

τ_a : Permissible torsion stress of the spline shaft (49 N/mm²)

Z_P : Polar modulus of section of the spline nut (mm³)

(see Table3 on **A3-17**, Table4 on **A3-18**, Table5 on **A3-19** and Table6 on **A3-20**)

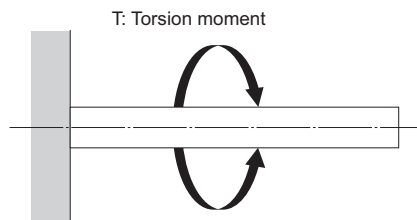

[Reference] Section Modulus (Solid Circle)

$$Z_P = \frac{\pi \cdot d^3}{16}$$

Z_P : Section modulus (mm³)

d : Shaft outer diameter (mm)

[When the Spline Shaft Simultaneously Receives a Bending Load and a Torsion Load]

When the spline shaft of a Ball Spline receives a bending load and a torsion load simultaneously, calculate two separate spline shaft diameters: one for the equivalent bending moment (M_e) and the other for the equivalent torsion moment (T_e). Then, use the greater value as the spline shaft diameter.

Equivalent bending moment

$$M_e = \frac{M + \sqrt{M^2 + T^2}}{2} = \frac{M}{2} \left\{ 1 + \sqrt{1 + \left(\frac{T}{M}\right)^2} \right\} \dots\dots\dots(3)$$

$$M_e = \sigma \cdot Z$$

Equivalent torsion moment

$$T_e = \sqrt{M^2 + T^2} = M \cdot \sqrt{1 + \left(\frac{T}{M}\right)^2} \dots\dots\dots(4)$$

$$T_e = \tau_a \cdot Z_p$$

[Rigidity of the Spline Shaft]

The rigidity of the spline shaft is expressed as a torsion angle per meter of shaft length. Its value should be limited within $1^\circ/4$.

$$\theta = 57.3 \times \frac{T \cdot L}{G \cdot I_p} \dots\dots\dots(5)$$

$$\text{Rigidity of the shaft} = \frac{\text{Torsion angle}}{\text{Unit length}} = \frac{\theta \cdot \ell}{L} < \frac{1^\circ}{4}$$

θ : Torsion angle (°)

L : Spline shaft length (mm)

G : Transverse elastic modulus
(7.9×10^4 N/mm²)

ℓ : Unit length (1000 mm)

I_p : Polar moment of inertia (mm⁴)

(see Table3 on **A3-17**, Table4 on **A3-18**, Table5 on **A3-19** and Table6 on **A3-20**)

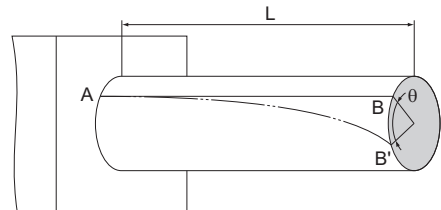

[Deflection and Deflection Angle of the Spline Shaft]

The deflection and deflection angle of the Ball Spline shaft need to be calculated using equations that meet the relevant conditions. Table1 and Table2 represent these conditions and the corresponding equations.

Table3 on **A3-17**, Table4 on **A3-18**, Table5 on **A3-19** and Table6 on **A3-20** show the section modulus of the spline shaft (Z) and the second moment of area (I). Using the Z and I values from the tables, the strength and displacement (deflection) of a typical ball spline within each model type can be obtained.

Table1 Deflection and Deflection Angle Equations

Support method	Condition	Deflection equation	Deflection angle equation
Both ends free		$\delta_{\max} = \frac{P\ell^3}{48EI}$	$i_1 = 0$ $i_2 = \frac{P\ell^2}{16EI}$
Both ends fastened		$\delta_{\max} = \frac{P\ell^3}{192EI}$	$i_1 = 0$ $i_2 = 0$
Both ends free		$\delta_{\max} = \frac{5p\ell^4}{384EI}$	$i_2 = \frac{p\ell^3}{24EI}$
Both ends fastened		$\delta_{\max} = \frac{p\ell^4}{384EI}$	$i_2 = 0$

Table2 Deflection and Deflection Angle Equations

Support method	Condition	Deflection equation	Deflection angle equation
One end fastened		$\delta_{\max} = \frac{P\ell^3}{3EI}$	$i_1 = \frac{P\ell^2}{2EI}$ $i_2 = 0$
One end fastened		$\delta_{\max} = \frac{p\ell^4}{8EI}$	$i_1 = \frac{p\ell^3}{6EI}$ $i_2 = 0$
Both ends free		$\delta_{\max} = \frac{\sqrt{3}M_0\ell^2}{216EI}$	$i_1 = \frac{M_0\ell}{12EI}$ $i_2 = \frac{M_0\ell}{24EI}$
Both ends fastened		$\delta_{\max} = \frac{M_0\ell^2}{216EI}$	$i_1 = \frac{M_0\ell}{16EI}$ $i_2 = 0$

 δ_{\max} : Maximum deflection (mm) M_0 : Moment (N·mm) ℓ : Span (mm)I: Geometrical moment of inertia (mm⁴) i_1 : Deflection angle at loading point i_2 : Deflection angle at supporting point

P: Concentrated load (N)

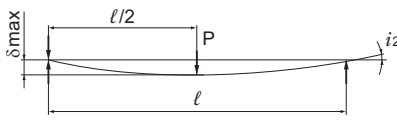
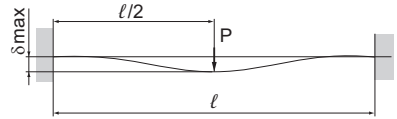
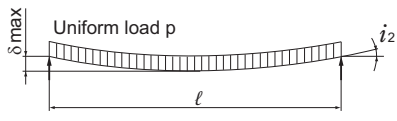
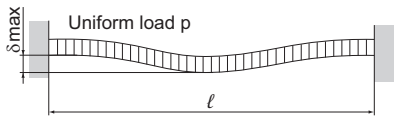
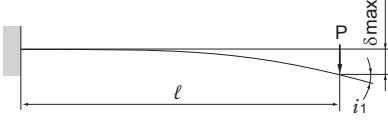
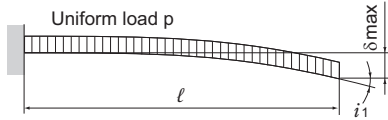
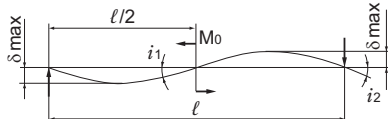
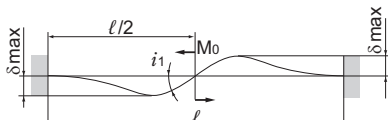
p: Uniform load (N/mm)

E: Modulus of longitudinal elasticity 2.06×10^5 (N/mm²)

[Dangerous Speed of the Spline Shaft]

When a Ball Spline shaft is used to transmit power while rotating, as the rotational speed of the shaft increases, the rotation cycle nears the natural frequency of the spline shaft. It may cause resonance and eventually result in inability to move. Therefore, the maximum rotational speed of the shaft must be limited to below the dangerous speed that does not cause resonance.

The dangerous speed of the spline shaft is obtained using the equation (6).

(0.8 is multiplied as a safety factor)

If the shaft's rotation cycle exceeds or nears the resonance point during operation, it is necessary to reconsider the spline shaft diameter.

● Dangerous Speed

$$N_c = \frac{60\lambda^2}{2\pi \cdot l_b^2} \cdot \sqrt{\frac{E \times 10^3 \cdot I}{\gamma \cdot A}} \times 0.8 \quad \dots(6)$$

N_c : Dangerous speed (min⁻¹)

l_b : Distance between two mounting surfaces (mm)

E : Young's modulus (2.06 × 10⁵ N/mm²)

I : Minimum geometrical moment of inertia of the shaft (mm⁴)

$$I = \frac{\pi}{64} d^4 \quad d: \text{Minor diameter (mm)}$$

(see Table10, Table11, Table12 and Table13 on **A3-24**)

γ : Density (specific gravity)
(7.85 × 10⁻⁶ kg/mm³)

$$A = \frac{\pi}{4} d^2 \quad d: \text{Minor diameter (mm)}$$

(see Table10, Table11, Table12 and Table13 on **A3-24**)

A : Spline shaft cross-sectional area (mm²)

λ : Factor according to the mounting method

(1) Fixed - free $\lambda=1.875$

(2) Supported - supported $\lambda=3.142$

(3) Fixed - supported $\lambda=3.927$

(4) Fixed - fixed $\lambda=4.73$

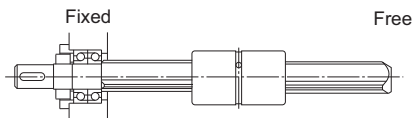

Fixed - free

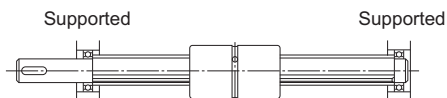

Supported - supported

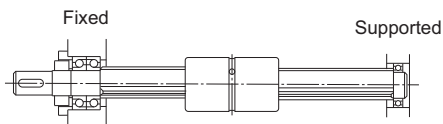

Fixed - supported

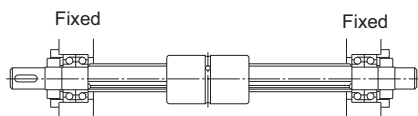

Fixed - fixed

Predicting the Service Life

[Static Safety Factor]

To calculate a load applied to the ball spline, you must first know the average load used to calculate the service life and the maximum load used to calculate the static safety factor.

In particular, if the system starts and stops frequently, or if impact loads are applied, a large moment load or torque caused by overhung loads may be applied to the system. When selecting a model number, make sure that the desired model is capable of handling the required maximum load (whether stationary or in motion). The reference values for the static safety factor are shown in the table below.

$$f_s = \frac{f_T \cdot f_c \cdot C_0}{P_{max}}$$

- f_s : Static safety factor
 C_0 : Basic static load rating* (N)
 P_{max} : Maximum applied load (N)
 f_T : Temperature factor (see Fig.1 on **A3-23**)
 f_c : Contact factor (see Table8 on **A3-23**)

*The basic static load rating is a static load of a defined direction and size where the sum of the permanent deformation of the ball and that of the rolling groove at the contact area under maximum stress is 0.0001 times the ball diameter.

Table3 Reference Values of Static Safety Factor (f_s)

Machine using the Ball Spline	Load conditions	Minimum reference values
General industrial machinery	Without vibration or impact	3.0 to 6.0
	Without vibration or impact	4.0 to 7.0
	With vibration or impact under combined loads	5.0 to 8.0

*The reference values for the static safety factor may vary depending on the load conditions as well as the environment, lubrication status, precision of the mounted surface, and/or rigidity.

[Nominal Life]

The service life of a Ball Spline varies from unit to unit even if they are manufactured through the same process and used in the same operating conditions. Therefore, the nominal life defined below is normally used as a guidepost for obtaining the service life of a Ball Spline.

Nominal life is the total travel distance that 90% of a group of identical ball splines independently operating under the same conditions can achieve without showing flaking (scale-like pieces on a metal surface).

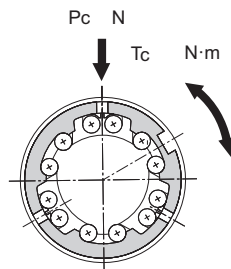

[Calculating the Nominal Life]

The nominal life of a ball spline varies with the types of loads applied during operation: torque load, radial load, and moment load. The corresponding nominal life values are obtained using the formulas (7) to (12) below. (The basic load ratings in these loading directions are indicated in the specification table for the corresponding model number.)

● Calculating the Nominal Life

The nominal life of the THK ball spline is defined as 50 km. The nominal life (L_{10}) is calculated from the basic dynamic load rating (C) and the load acting on the ball spline (P_c) using the following formulas.

- When a torque load is applied

$$L_{10} = \left(\frac{C_T}{T_c} \right)^3 \times 50 \quad \dots\dots(7)$$

L_{10} : Nominal life (km)

C_T : Basic dynamic torque rating (N·m)

C : Basic dynamic load rating (N)

T_c : Calculated torque applied (N·m)

P_c : Calculated radial load (N)

- When a radial load is applied

$$L_{10} = \left(\frac{C}{P_c} \right)^3 \times 50 \quad \dots\dots(8)$$

*These nominal life formulas may not apply if the length of the stroke is less than or equal to twice the length of the ball spline nut.

When comparing the nominal life (L_{10}), you must take into account whether the basic dynamic load rating was defined based on 50 km or 100 km. Convert the basic dynamic load rating based on ISO 14728-1 as necessary.

ISO-regulated basic dynamic load rating conversion formula:

$$C_{100} = \frac{C_{50}}{1.26}$$

C_{50} : Basic dynamic load rating based on a nominal life of 50 km

C_{100} : Basic dynamic load rating based on a nominal life of 100 km

● Calculating the Modified Nominal Life

During use, a ball spline may be subjected to vibrations and shocks as well as fluctuating loads, which are difficult to detect. In addition, the operating temperature and having nuts arranged in close contact will significantly impact the service life. Taking these factors into account, the modified nominal life (L_{10m}) can be calculated according to the following formulas (9) and (10).

- Modified factor α

$$\alpha = \frac{f_T \cdot f_c}{f_w}$$

α : Modified factor

f_T : Temperature factor (see Fig.1 on **B3-22**)

f_c : Contact factor (see Table4 on **B3-22**)

f_w : Load factor (see Table 5 on **B3-22**)

- Modified nominal life L_{10m}

- When a torque load is applied

$$L_{10m} = \left(\alpha \times \frac{C_T}{T_c} \right)^3 \times 50 \quad \dots\dots(9)$$

L_{10m} : Modified nominal life (km)

C_T : Basic dynamic torque rating (N·m)

C : Basic dynamic load rating (N)

T_c : Calculated torque applied (N·m)

P_c : Calculated radial load (N)

- When a radial load is applied

$$L_{10m} = \left(\alpha \times \frac{C}{P_c} \right)^3 \times 50 \quad \dots\dots(10)$$

● **When a Torque Load and a Radial Load are Simultaneously Applied**

When a torque load and a radial load are simultaneously applied, calculate the nominal life by obtaining the equivalent radial load using the equation (11) below.

$$P_E = P_c + \frac{4 \cdot T_c \times 10^3}{i \cdot dp \cdot \cos \alpha} \quad \dots\dots(11)$$

P_E : Equivalent radial load (N)

$\cos \alpha$: Contact angle i =Number of rows of balls under a load

Type LBS $\alpha=45^\circ$	$i=3$	Type SLS $\alpha=40^\circ$	$i=3$
Type LT $\alpha=70^\circ$	$i=2$ (LT13 or smaller)	Type LT-X $\alpha=65^\circ$	$i=2$
$i=3$ (LT16 or greater)			

dp : Ball center-to-center diameter (mm)
(see Table10, Table11, Table12 and Table13 on **A3-24**)

● **When a Moment Load is Applied to a Single Nut or Two Nuts in Close Contact with Each Other**

Obtain the equivalent radial load using the equation (12) below.

$$P_u = K \cdot M \quad \dots\dots(12)$$

P_u : Equivalent radial load (N)
(with a moment applied)

K : Equivalent Factors
(see Table14 on **A3-27**, Table15 on **A3-28**, Table16 and Table17 on **A3-29**)

M : Applied moment (N·mm)

However, M should be within the range of the static permissible moment.

● **When a Moment Load and a Radial Load are Simultaneously Applied**

Calculated the nominal life from the sum of the radial load and the equivalent radial load.

● **Calculating the Service Life Time**

When the nominal life (L_{10}) has been obtained in the equation above, if the stroke length and the number of reciprocations per minute are constant, the service life time is obtained using the formula (13) below.

$$L_h = \frac{L_{10} \times 10^3}{2 \times \ell_s \times n_1 \times 60} \quad \dots\dots(13)$$

L_h : Service life time (h)

ℓ_s : Stroke length (m)

n_1 : Number of reciprocations per minute (min⁻¹)

■ f_t : Temperature Factor

If the temperature of the environment surrounding the operating Ball Spline exceeds 100°C, take into account the adverse effect of the high temperature and multiply the basic load ratings by the temperature factor indicated in Fig.1.

In addition, the Ball Spline must be of a high temperature type.

Note) If the environment temperature exceeds 80°C, high-temperature types of seal and retainer are required. ContactTHK for details.

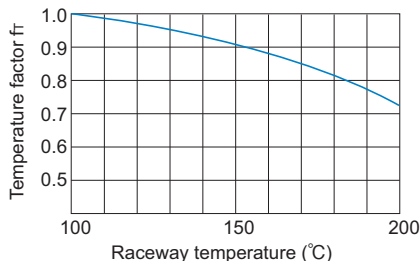

Fig.1 Temperature Factor (f_t)

■ f_c : Contact Factor

When multiple spline nuts are used in close contact with each other, their linear motion is affected by moments and mounting accuracy, making it difficult to achieve uniform load distribution. In such applications, multiply the basic load rating (C) and (C_0) by the corresponding contact factor in Table4.

Note) If uneven load distribution is expected in a large machine, take into account the respective contact factor indicated in Table4.

Table4 Contact Factor (f_c)

Number of spline nuts in close contact with each other	Contact factor f_c
2	0.81
3	0.72
4	0.66
5	0.61
Normal use	1

■ f_w : Load Factor

In general, reciprocating machines tend to experience vibrations or impacts during operation, and it is difficult to accurately determine the vibrations generated during high-speed operation and impacts during frequent starts and stops. When the actual load applied to a ball spline cannot be obtained, or when speed and vibrations have a significant influence, divide the basic dynamic load rating (C) by the corresponding load factor in Table 5, which has been empirically obtained.

Table 5 Load Factor (f_w)

Vibrations/ impact	Speed (V)	f_w
Faint	Very low $V \leq 0.25\text{m/s}$	1 to 1.2
Weak	Slow $0.25 < V \leq 1\text{m/s}$	1.2 to 1.5
Medium	Medium $1 < V \leq 2\text{m/s}$	1.5 to 2
Strong	High $V > 2\text{m/s}$	2 to 3.5

[Calculating the Average Load]

When the load applied on the spline shaft fluctuates according to varying conditions, such as an industrial robot arm traveling forward while holding a workpiece and traveling backward with empty weight, and a machine tool handling various workpieces, this varying load condition must be taken into account in service life calculation.

The average load (P_m) is a constant load under which the service life of an operating Ball Spline with its spline nut receiving a fluctuation load in varying conditions is equivalent to the service life under this varying load condition.

The following is the basic equation.

$$P_m = \sqrt[3]{\frac{1}{L} \cdot \sum_{n=1}^n (P_n^3 \cdot L_n)}$$

P_m : Average Load (N)

P_n : Varying load (N)

L : Total travel distance (mm)

L_n : Distance traveled under P_n (mm)

● When the Load Fluctuates Stepwise

$$P_m = \sqrt[3]{\frac{1}{L} (P_1^3 \cdot L_1 + P_2^3 \cdot L_2 + \dots + P_n^3 \cdot L_n)} \dots\dots\dots (14)$$

P_m : Average Load (N)

P_n : Varying load (N)

L : Total travel distance (m)

L_n : Distance traveled under load P_n (m)

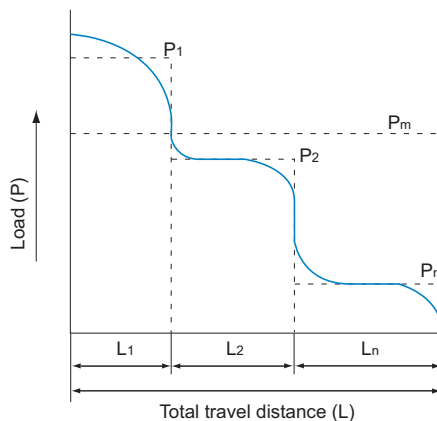

Fig.2

● When the Load Fluctuates Monotonically

$$P_m \doteq \frac{1}{3} (P_{\min} + 2 \cdot P_{\max}) \dots\dots\dots (15)$$

P_{\min} : Minimum load (N)

P_{\max} : Maximum load (N)

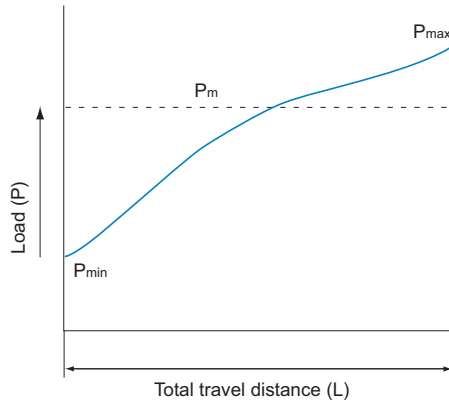

Fig.3

● When the Load Fluctuates Sinusoidally

(a) $P_m \doteq 0.65P_{\max} \dots\dots\dots (16)$

(b) $P_m \doteq 0.75P_{\max} \dots\dots\dots (17)$

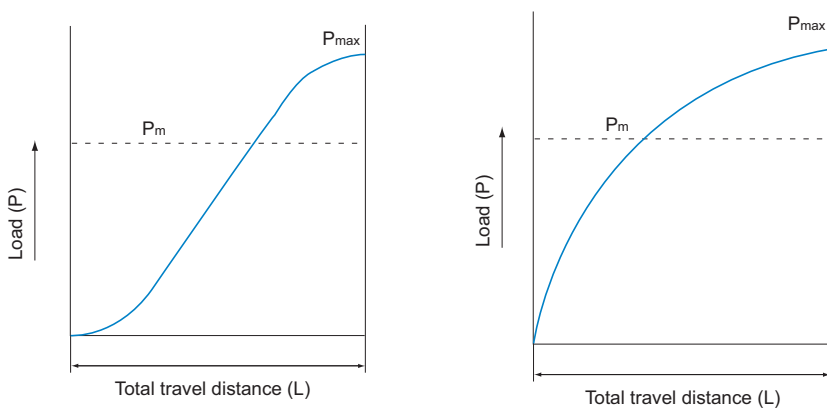

Fig.4

[Equivalent Factor]

Table14 on **A3-27**, Table15 on **A3-28**, Table16 and Table17 on **A3-29** show equivalent radial load factors calculated under a moment load.

Example of Calculating the Service Life

● Example of Calculation - 1

An industrial robot arm (horizontal)

[Conditions]

Mass applied to the arm end $m=50$ kg

Arm length at maximum stroke $L_{\max}=400$ mm

Stroke $\ell_s=200$ mm

$L_2=325$ mm

Spline nut mounting span (estimate) $L_1=150$ mm

$L_3=50$ mm

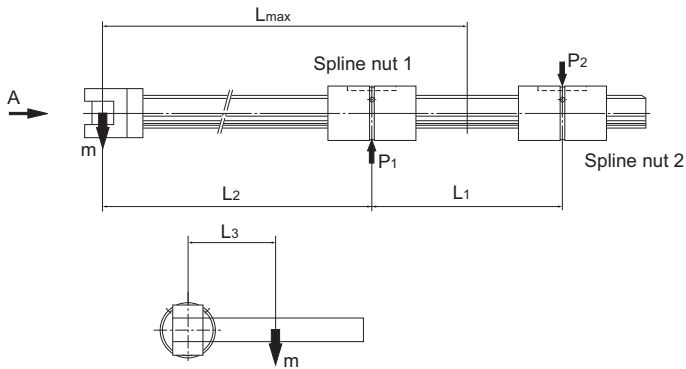

A arrow view

(The Ball Spline type is LBS in this example.)

Fig.5

■ Shaft Strength Calculation

Calculate the bending moment (M) and the torsion moment (T) applied on the shaft.

$$M = m \times 9.8 \times L_{\max} = 196000 \text{ N} \cdot \text{mm}$$

$$T = m \times 9.8 \times L_3 = 24500 \text{ N} \cdot \text{mm}$$

Since the bending and torsion moments are applied simultaneously, obtain the corresponding bending moment (M_e) and torsion moment (T_e), and then determine the shaft diameter based on the greater value. From equations (3) and (4) on **B3-15**,

$$M_e = \frac{M + \sqrt{M^2 + T^2}}{2} = 196762.7 \text{ N} \cdot \text{mm}$$

$$T_e = \sqrt{M^2 + T^2} = 197525.3 \text{ N} \cdot \text{mm}$$

$$M_e < T_e$$

$\therefore T_e = \tau_a \times Z_p$ Hence,

$$Z_p = \frac{T_e}{\tau_a} = 4031 \text{ mm}^3$$

Thus, judging from Table4 on **A3-18**, the nominal shaft diameter that meets Z_p is at least 40 mm.

■Average Load P_m

Obtain an applied load value when the arm is extended to the maximum length (P_{max}), and another when the arm is contracted (P_{min}). Based on the values obtained, calculate the average load on the spline shaft nut.

$$P_{1max} = \frac{m \times 9.8(L_1 + L_2)}{L_1} = 1551.7 \text{ N}$$

$$P_{2max} = \frac{m \times 9.8 \times L_2}{L_1} = 1061.7 \text{ N}$$

When the arm is contracted

$$P_{1min} = \frac{m \times 9.8 \times [(L_2 - \ell_s) + L_1]}{L_1} = 898.3 \text{ N}$$

$$P_{2min} = \frac{m \times 9.8 \times (L_2 - \ell_s)}{L_1} = 408.3 \text{ N}$$

As this load is monotonically varying as shown in the Fig.3 on **B3-24**, calculate the average load using the equation (15) on **B3-24**.

The average load (P_{1m}) on spline nut 1

$$P_{1m} = \frac{1}{3}(P_{1min} + 2P_{1max}) = 1333.9 \text{ N}$$

The average load (P_{2m}) on spline nut 2

$$P_{2m} = \frac{1}{3}(P_{2min} + 2P_{2max}) = 843.9 \text{ N}$$

Obtain the torque applied on one spline nut.

$$T = \frac{m \times 9.8 \times L_3}{2} = 12250 \text{ N} \cdot \text{mm}$$

Since the radial load and the torque are simultaneously applied, calculate the equivalent radial load using equation (11) on **B3-21**.

$$P_{1E} = P_{1m} + \frac{4 \times T}{3 \times dp \times \cos \alpha} = 1911.4 \text{ N}$$

$$P_{2E} = P_{2m} + \frac{4 \times T}{3 \times dp \times \cos \alpha} = 1421.4 \text{ N}$$

■Nominal Life L_n

Based on the nominal life equation (10) on **B3-20**, each nominal life is obtained as follows.

$$\text{Nominal life of the spline nut } L_{10m1} = \left(\alpha \times \frac{C}{P_{1E}} \right)^3 \times 50 = 68867.4 \text{ km}$$

$$\text{Nominal life of the spline nut } L_{10m2} = \left(\alpha \times \frac{C}{P_{2E}} \right)^3 \times 50 = 167463.2 \text{ km}$$

$$\alpha = \frac{f_r \cdot f_c}{f_w}$$

- f_T : Temperature factor = 1 (from Fig.1 on B3-22)
 f_C : Contact factor = 1 (from Table4 on B3-22)
 f_W : Load factor = 1.5 (from Table 5 on B3-22)
 C: Basic dynamic load rating = 31.9 kN (model LBS40)

Given the nominal life obtained for each spline nut above, the nominal life of the Ball Spline unit is equal to that of spline nut 1, which is 68867.4 km.

● Example of Calculation - 2

[Conditions]

Thrust position: F_s

Stroke velocity: $V_{\max} = 0.25$ m/s

Acceleration: $a = 0.36$ m/s²

(from the respective velocity diagram)

Stroke: $S = 700$ mm

Housing mass: $m_1 = 30$ kg

Arm mass : $m_2 = 20$ kg

Head mass: $m_3 = 15$ kg

Work mass: $m_4 = 12$ kg

Distance from the thrust position to each mass

$l_1 = 200$ mm $l_2 = 500$ mm

$l_3 = 1276$ mm

Cycle (1 cycle: 30 s)

1. Descent (3.5 s)
2. Dwell (1 s): with a work
3. Ascend (3.5 s)
4. Dwell (7 s)
5. Descent (3.5 s)
6. Dwell (1 s): without a work
7. Ascend (3.5 s)
8. Dwell (7 s)

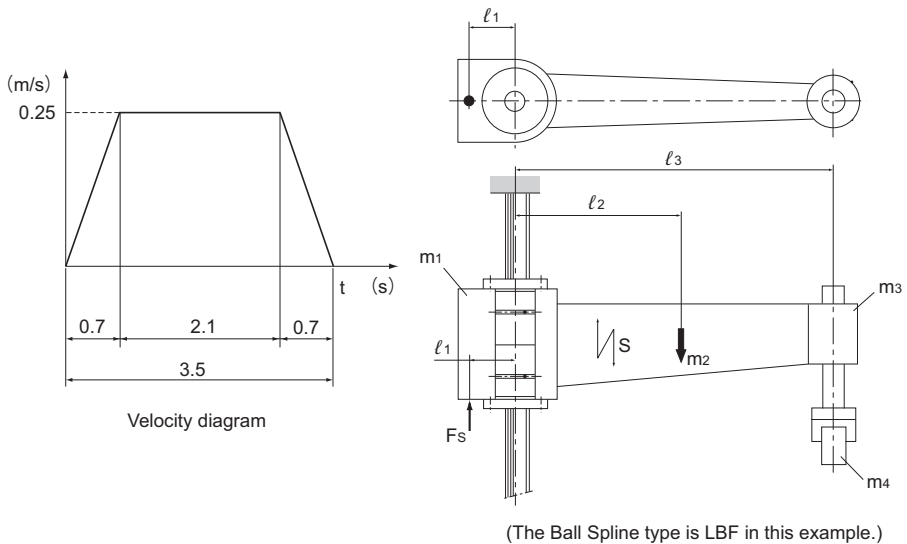

Fig.6

■ Shaft Strength Calculation

Calculate the shaft strength while assuming the shaft diameter to be 60 mm. (with double spline nut in contact with each other)

■ Calculating the Moment (M_n) Applying on the Spline Nut during Acceleration, Uniform Motion and Deceleration with Different Masses (m_n)

Applied moment during deceleration: M_1

$$M_1 = m_n \times 9.8 \left(1 \pm \frac{a}{g}\right) \times l_n \quad \dots\dots(a)$$

Applied moment during uniform motion: M_2

$$M_2 = m_n \times 9.8 \times l_n \quad \dots\dots(b)$$

Applied moment during deceleration: M_3

$$M_3 = m_n \times 9.8 \left(1 \pm \frac{a}{g}\right) \times l_n \quad \dots\dots(c)$$

m_n : Mass (kg)

a : Acceleration (m/s²)

g : Gravitational acceleration (m/s²)

l_n : Offset from each loading point to the trust center (mm)

Assume:

$$A = \left(1 + \frac{a}{g}\right), \quad B = \left(1 - \frac{a}{g}\right)$$

- During descent

From equation (c), during acceleration

$$\begin{aligned} M_{m1} &= m_1 \times 9.8 \times B \times l_1 + m_2 \times 9.8 \times B \times (l_1 + l_2) + m_3 \times 9.8 \times B \times (l_1 + l_3) \\ &= 398105.01 \text{ N}\cdot\text{mm} \end{aligned}$$

From equation (b), during uniform motion

$$\begin{aligned} M_{m2} &= m_1 \times 9.8 \times l_1 + m_2 \times 9.8 \times (l_1 + l_2) + m_3 \times 9.8 \times (l_1 + l_3) \\ &= 412972 \text{ N}\cdot\text{mm} \end{aligned}$$

From equation (a), during deceleration

$$\begin{aligned} M_{m3} &= m_1 \times 9.8 \times A \times l_1 + m_2 \times 9.8 \times A \times (l_1 + l_2) + m_3 \times 9.8 \times A \times (l_1 + l_3) \\ &= 427838.99 \text{ N}\cdot\text{mm} \end{aligned}$$

- During ascent

From equation (a), during acceleration

$$\begin{aligned} M_{m1}' &= m_1 \times 9.8 \times A \times l_1 + m_2 \times 9.8 \times A \times (l_1 + l_2) + m_3 \times 9.8 \times A \times (l_1 + l_3) \\ &= 427838.99 \text{ N}\cdot\text{mm} \end{aligned}$$

From equation (b), during uniform motion

$$\begin{aligned} M_{m2}' &= m_1 \times 9.8 \times l_1 + m_2 \times 9.8 \times (l_1 + l_2) + m_3 \times (l_1 + l_3) \\ &= 412972 \text{ N}\cdot\text{mm} \end{aligned}$$

From equation (c), during deceleration

$$M_{m3}' = m_1 \times 9.8 \times B \times \ell_1 + m_2 \times 9.8 \times B \times (\ell_1 + \ell_2) + m_3 \times 9.8 \times B \times (\ell_1 + \ell_3) \\ = 398105.01 \text{ N}\cdot\text{mm}$$

- During descent (with a work loaded)

From equation (c), during acceleration

$$M_{m1}'' = M_{m1} + m_4 \times 9.8 \times B \times (\ell_1 + \ell_3) \\ = 565433.83 \text{ N}\cdot\text{mm}$$

From equation (b), during uniform motion

$$M_{m2}'' = M_{m2} + m_4 \times 9.8 \times (\ell_1 + \ell_3) \\ = 586549.6 \text{ N}\cdot\text{mm}$$

From equation (a), during deceleration

$$M_{m3}'' = M_{m3} + m_4 \times 9.8 \times A \times (\ell_1 + \ell_3) \\ = 607665.37 \text{ N}\cdot\text{mm}$$

- During ascent (with a work loaded)

From equation (a), during acceleration

$$M_{m1}''' = M_{m1}' + m_4 \times 9.8 \times A \times (\ell_1 + \ell_3) \\ = 607665.37 \text{ N}\cdot\text{mm}$$

From equation (b), during uniform motion

$$M_{m2}''' = M_{m2}' + m_4 \times 9.8 \times (\ell_1 + \ell_3) \\ = 586549.6 \text{ N}\cdot\text{mm}$$

From equation (c), during deceleration

$$M_{m3}''' = M_{m3}' + m_4 \times 9.8 \times B \times (\ell_1 + \ell_3) \\ = 565433.83 \text{ N}\cdot\text{mm}$$

$$\therefore M_1 = M_{m1} = M_{m3}' = 398105.01 \text{ N}\cdot\text{mm}$$

$$M_2 = M_{m2} = M_{m2}' = 412972 \text{ N}\cdot\text{mm}$$

$$M_3 = M_{m3} = M_{m1}' = 427838.99 \text{ N}\cdot\text{mm}$$

$$M_1' = M_{m1}'' = M_{m3}''' = 565433.83 \text{ N}\cdot\text{mm}$$

$$M_2' = M_{m2}'' = M_{m2}''' = 586549.6 \text{ N}\cdot\text{mm}$$

$$M_3' = M_{m3}'' = M_{m1}''' = 607665.37 \text{ N}\cdot\text{mm}$$

■Calculating the Equivalent Radial Load Considered to be Applied to the Spline Nut with Different Moments

Relational expression between moment M_n and P_n

$$P_n = M_n \times K \quad \dots\dots(d)$$

P_n : Equivalent radial load (N)

M_n : Applied moment (N·mm)

K : Equivalent factor

(from Table 15 to **A3-28**)

(If two spline nuts of LBF60 contact with each other, $K = 0.013$)

Calculate the equivalent radial load with different applied moments using equation (d).

$$P_{m1} = P_{m3}' = M_1 \times 0.013 \doteq 5175.4 \text{ N}$$

$$P_{m2} = P_{m2}' = M_2 \times 0.013 \doteq 5368.6 \text{ N}$$

$$P_{m3} = P_{m1}' = M_3 \times 0.013 \doteq 5561.9 \text{ N}$$

$$P_{m1}'' = P_{m3}''' = M_1' \times 0.013 \doteq 7350.7 \text{ N}$$

$$P_{m2}'' = P_{m2}''' = M_2' \times 0.013 \doteq 7625.2 \text{ N}$$

$$P_{m3}'' = P_{m1}''' = M_3' \times 0.013 \doteq 7899.7 \text{ N}$$

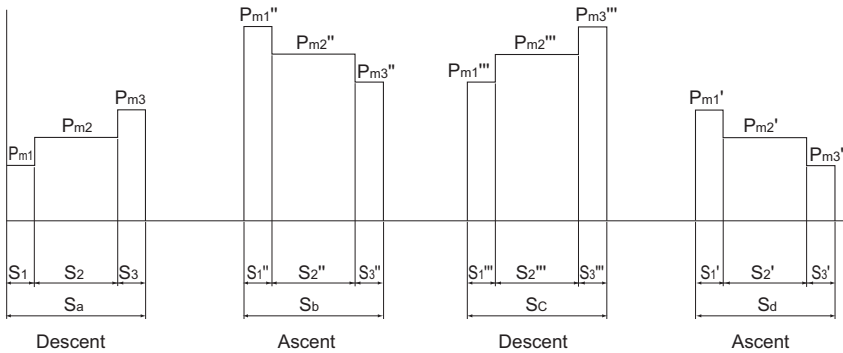

$$\left\{ \begin{array}{l} P_1 = P_{m1} = P_{m3}' \doteq 5175.4 \text{ N} \\ P_2 = P_{m2} = P_{m2}' \doteq 5368.6 \text{ N} \\ P_3 = P_{m3} = P_{m1}' \doteq 5561.9 \text{ N} \end{array} \right. \quad \left\{ \begin{array}{l} P_4 = P_{m1}'' = P_{m3}''' \doteq 7350.7 \text{ N} \\ P_5 = P_{m2}'' = P_{m2}''' \doteq 7625.2 \text{ N} \\ P_6 = P_{m3}'' = P_{m1}''' \doteq 7899.7 \text{ N} \end{array} \right. \quad \left\{ \begin{array}{l} S = S_a = S_b = S_c = S_d = 700 \text{ mm} \\ S_1 = S_1' = S_1'' = S_1''' = S_1'''' = 87.5 \text{ mm} \\ S_2 = S_2' = S_2'' = S_2''' = S_2'''' = 525 \text{ mm} \\ S_3 = S_3' = S_3'' = S_3''' = S_3'''' = 87.5 \text{ mm} \end{array} \right.$$

■Calculating the Average Load P_m

Using equation (14) on **B3-23**,

$$P_m = \sqrt[3]{\frac{1}{4 \times S} \{ 2 \{ (P_1^3 \times S_1) + (P_2^3 \times S_2) + (P_3^3 \times S_3) \} + 2 \{ (P_4^3 \times S_3) + (P_5^3 \times S_2) + (P_6^3 \times S_1) \} \}}$$

$$\doteq 6689.5 \text{ N}$$

■Calculating the Rated Life L from the Average Load

Using equation (10) on **B3-20**,

$$L_{10m} = \left(\alpha \times \frac{C}{P_m} \right)^3 \times 50$$

$$= 7630 \text{ km}$$

$$\alpha = \frac{f_r \cdot f_c}{f_w}$$

f_r : Temperature factor = 1

(from Fig. 1 on **B3-22**)

f_c : Contact factor = 0.81

(from Table 4 on **B3-22**)

f_w : Load factor = 1.5

(from Table 5 on **B3-22**)

C : Basic dynamic load rating = 66.2 kN

(model LBF60)

Given the result above, the nominal life of model LBF60 with double spline nuts used in close contact with each other is 7,630 km.

Assembling the Ball Spline

Mounting the Spline

Fig.1 and Fig.2 shows examples of mounting the spline nut. Although the Ball Spline does not require a large strength for securing it in the spline shaft direction, do not support the spline only with driving fitting.

Note) On both ends of the spline nut of Caged Ball Ball Spline model SLS, resin end caps are installed. Hitting them or pressing hard may cause damage. You must take care not to apply an excessive load.

Straight nut type

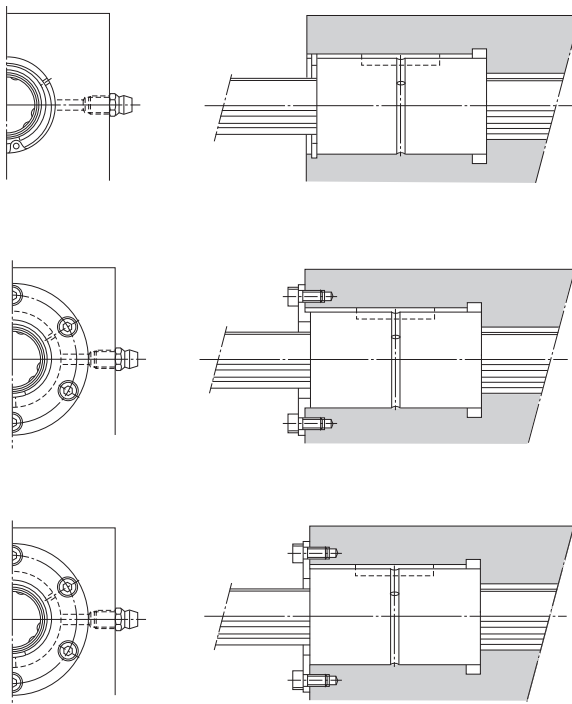
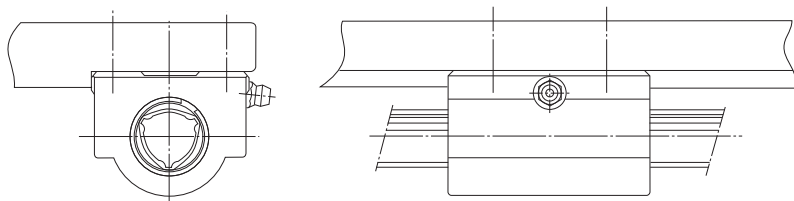
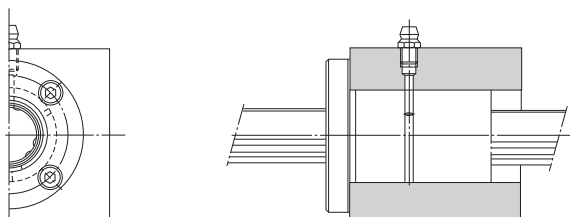

Fig.1 Examples of Fitting the Spline Nut

Model LBH



Flanged type



Model LTR

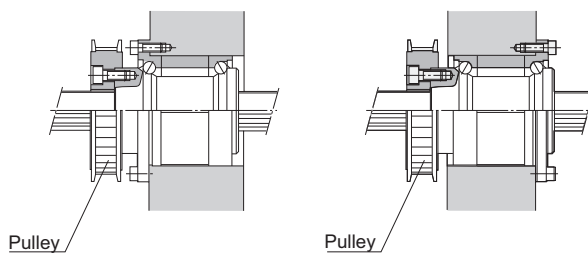

Model LBG

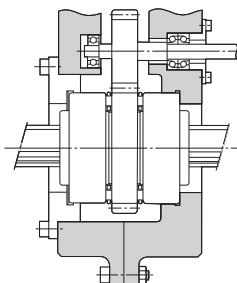

Fig.2 Examples of Fitting the Spline Nut

Mounting Procedure and Maintenance

Assembling the Ball Spline

Installing the Spline Nut

When installing the spline nut into the housing, do not hit the side plate or the seal, but gently insert it using a jig (Fig.3).

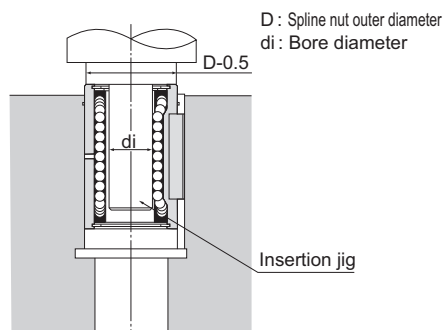

Fig.3

Table1 Dimensions of the Jig for Model LBS

Unit: mm

Nominal shaft diameter	15	20	25	30	40	50	60	70	85	100	120	150
di	12.5	16.1	20.3	24.4	32.4	40.1	47.8	55.9	69.3	83.8	103.8	131.8

Table2 Dimensions of the Jig for Model LT

Unit: mm

Nominal shaft diameter	6	8	10	13	16	20	25	30	40	50	60	80	100
di	5.0	7	8.5	11.5	14.5	18.5	23	28	37.5	46.5	56	75.5	94.5

Installation of the Spline Shaft

When installing the spline shaft into the spline nut, identify the matching marks (Fig.4) on the spline shaft and the spline nut, and then insert the shaft straightforward while checking their relative positions.

Note that forcibly inserting the shaft may cause balls to fall off.

If the spline nut is attached with a seal or given a preload, apply a lubricant to the outer surface of the spline shaft.

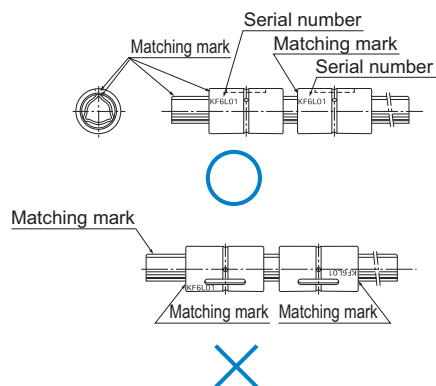

Fig.4

Lubrication

To prevent foreign material from entering the spline nut and the lubricant from leaking, special synthetic resin seals with high wear resistance are available for the Ball Spline.

Spline nuts with seals (UU seals for both ends and seals for one end) contain lithium soap-based grease No. 2. If using at high speed or with a long stroke, replenish grease of the same type through the lubrication hole on the spline nut after running in.

Afterward, replenish grease of the same type as necessary according to the service conditions.

The greasing interval differs depending on the conditions. Normally, replenish the lubricant (or replace the product) roughly every 100 km of travel distance (three to six months) as a rule of thumb.

For a Ball Spline model type without a seal, apply grease to the interior of the spline nut or to the raceways of the spline shaft.

Material and Surface Treatment

Depending on the service environment, the Ball Spline requires anticorrosive treatment or a different material. For details of anticorrosive treatment and material change, contact THK.

Contamination Protection

Entrance of dust or other foreign material into the spline nut will cause abnormal wear or shorten the service life. Therefore, it is necessary to prevent detrimental foreign material from entering the Ball Spline. When entrance of dust or other foreign material is a possibility, it is important to select effective seals and/or dust-control device that meets the environment conditions.

For the Ball Spline, a special synthetic rubber seal that is highly resistant to wear is available as a contamination protection accessory. If desiring a higher contamination protection effect, a felt seal is also available for some types. For details about the felt seal, contact THK.

In addition, THK produces round bellows. Contact us for details.

Table1 Dust prevention accessory symbol

Symbol	Contamination protection accessory
No Symbol	Without seal
UU	Rubber seal attached on both ends of spline nut
U	Rubber seal attached on either end of spline nut
DD	Felt seal attached on both ends of spline nut
D	Felt seal attached on either end of spline nut
ZZ	Rubber seal attached on both ends of support bearings
Z	Rubber seal attached on either end of support bearings

Model Number Coding

Model number configurations differ depending on the model features. Refer to the corresponding sample model number configuration.

[Ball Spline]

- Models SLS, SLS-L, SLF, LBS, LBST, LBF, LBR, LBH, LT, LF, LT-X, LF-X, LFK-X and LFH-X

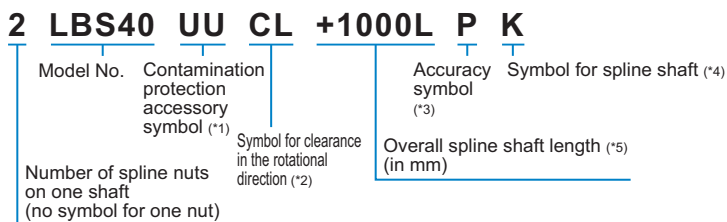

(*1) See [B3-126](#). (*2) See [B3-30](#). (*3) See [B3-35](#). (*4) See [B3-69](#). (*5) See [B3-121](#).

[Rotary Ball Spline]

- Models LTR, LTR-A, LBG and LBGT

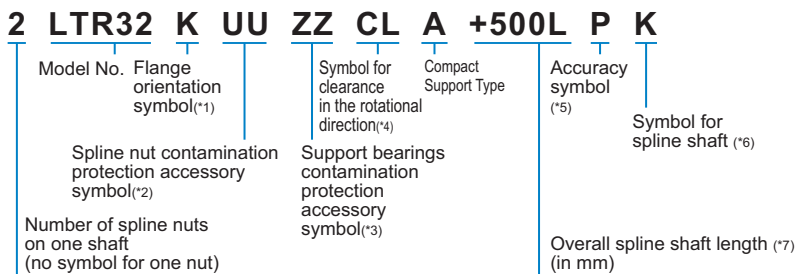

(*1) See [B3-126](#). (*2) See [B3-126](#). (*3) See [B3-30](#). (*4) See [B3-30](#). (*5) See [B3-35](#). (*6) See [B3-118](#). (*7) See [B3-121](#).

(*1) No Symbol: standard K: flange inverted

[Handling]

- (1) Please use at least two people to move any product weighing 20 kg or more, or use a dolly or another conveyance. Doing so may cause injury or damage.
- (2) Do not disassemble the parts. This will result in loss of functionality.
- (3) Tilting a spline nut or spline shaft may cause them to fall by their own weight.
- (4) Take care not to drop or strike the Ball Spline. Doing so may cause injury or damage. Giving an impact to it could also cause damage to its function even if the product looks intact.
- (5) When assembling, do not remove the spline nut from the spline shaft.
- (6) When handling the product, wear protective gloves, safety shoes, etc., as necessary to ensure safety.

[Precautions on Use]

- (1) Prevent foreign material, such as cutting chips or coolant, from entering the product. Failure to do so may cause damage.
- (2) If the product is used in an environment where cutting chips, coolant, corrosive solvents, water, etc., may enter the product, use bellows, covers, etc., to prevent them from entering the product.
- (3) Do not use the product at temperature of 80°C or higher. Except for the heat-resistant models, exposure to higher temperatures may cause the resin/rubber parts to deform/be damaged.
- (4) If foreign material such as cutting chips adheres to the product, replenish the lubricant after cleaning the product.
- (5) Micro-strokes tend to obstruct oil film to form on the raceway in contact with the rolling element, and may lead to fretting corrosion. Take consideration using grease offering excellent fretting prevention. It is also recommended that a stroke movement corresponding to the length of the spline nut be made on a regular basis to make sure oil film is formed between the raceway and rolling element.
- (6) Do not use undue force when fitting parts (pin, key, etc.) to the product. This may generate permanent deformation on the raceway, leading to loss of functionality.
- (7) Skewing or misalignment of the spline shaft support and spline nut can shorten service life substantially. Inspect the components carefully and make sure they are mounted correctly.
- (8) The spline nut must contain all its internal rolling elements (balls) when mounted on the spline shaft. Using a spline nut with any balls removed may result in premature damage.
- (9) Please contact THK if any balls fall out of the spline nut; do not use the spline nut if any balls are missing.
- (10) To mount the spline nut on the spline shaft, first locate the alignment indicators on both components, then insert the shaft through the opening in the spline nut, without forcing it, and adjust the position until the indicators are aligned. Forcing the shaft could cause balls to fall out. When mounting a spline nut equipped with a seal or preload, first lubricate the outer surface of the spline shaft.
- (11) Manipulate the spline nut gently, using a jig, when inserting it into the housing, taking care not to strike the side plate, end cap, or seal.
- (12) If an attached component is insufficiently rigid or mounted incorrectly, the bearing load will be concentrated at one location and performance will decline significantly. Make sure the housing and base are sufficiently rigid, the anchoring bolts are strong enough, and the component is mounted correctly.
- (13) If desiring to have a flanged-type Ball Spline additionally machined, such as having a dowel pin hole, contact THK.

[Lubrication]

- (1) Thoroughly wipe off anti-rust oil and feed lubricant before using the product.
- (2) Do not combine different lubricants. Mixing lubricants can cause adverse interaction between disparate additives or other ingredients.
- (3) If the product will be exposed to constant vibration or high or low temperatures, or used in a clean room, vacuum, or other special environment, apply a lubricant suitable for both the specifications and the environment.
- (4) To lubricate a product that has no grease nipple or lubrication hole, apply lubricant directly to the raceway surface and execute a few preliminary strokes to ensure that the interior is fully lubricated.
- (5) Bear in mind that the Ball Spline's slide resistance is affected by changes in the consistency of the lubricant, which varies according to the temperature.
- (6) The Ball Spline may encounter increased slide resistance following lubrication, due to the lubricant's agitation resistance. Make sure to put the unit through some preliminary motions to ensure that it is fully lubricated before starting up the machine.
- (7) Excess lubricant may spatter immediately after lubrication. If necessary, wipe off any spattered grease.
- (8) Because lubricant performance declines over time, lubrication must be monitored regularly and fresh lubricant applied when needed, depending on how frequently the machine is operated.
- (9) The appropriate lubrication schedule will depend on usage conditions and the surrounding environment. In general, the unit should be lubricated after every 100 kilometers of operation (every 3 to 6 months). The actual lubrication schedule and amount of lubricant used should be determined by the condition of the machinery.
- (10) With oil lubrication, the lubricant may not always be thoroughly disseminated inside the Ball Spline, depending on its mounting position. If the preferred lubrication method is oil lubrication, please consult THK in advance.

[Storage]

When storing the Ball Spline, enclose it in a package designated by THK and store it in a room in a horizontal orientation while avoiding high temperature, low temperature and high humidity. After the product has been in storage for an extended period of time, lubricant inside may have deteriorated, so add new lubricant before use.

[Disposal]

Dispose of the product properly as industrial waste.